



**COPPER MOUNTAIN**  
TECHNOLOGIES

## TR5048 and TR7530

Vector Network Analyzer

Operating Manual



Revision: 2.1  
Oct, 2014

# TABLE OF CONTENTS

<b>INTRODUCTION .....</b>	<b>7</b>
<b>SAFETY INSTRUCTIONS .....</b>	<b>8</b>
<b>1 GENERAL OVERVIEW .....</b>	<b>10</b>
1.1 Description .....	10
1.2 Specifications .....	10
1.2.1 Basic Specifications.....	10
1.2.2 Measurement Capabilities .....	14
1.3 Ordering Information .....	20
1.3.1 Standard Accessories.....	20
1.4 Principle of Operation .....	20
<b>2 PREPARATION FOR USE .....</b>	<b>22</b>
2.1 General Information.....	22
2.2 Software Installation .....	22
2.3 Front Panel .....	24
2.3.1 Test Ports .....	24
2.3.2 Power Switch .....	25
2.4 Rear Panel.....	26
2.4.1 Power Cable Receptacle .....	26
2.4.2 External Trigger Signal Input Connector.....	27
2.4.3 External Reference Frequency Connector.....	27
2.4.4 USB 2.0 High Speed .....	27
2.4.5 Earth Terminal .....	27
<b>3 GETTING STARTED .....</b>	<b>28</b>
3.1 Analyzer Preparation for Reflection Measurement.....	29
3.2 Analyzer Presetting.....	29
3.3 Stimulus Setting .....	29
3.4 IF Bandwidth Setting.....	30
3.5 Number of Traces, Measured Parameter and Display Format Setting.....	30
3.6 Trace Scale Setting .....	33
3.7 Analyzer Calibration for Reflection Coefficient Measurement .....	33
3.8 SWR and Reflection Coefficient Phase Analysis Using Markers .....	35
<b>4 MEASUREMENT CONDITIONS SETTING.....</b>	<b>36</b>
4.1 Screen Layout and Functions.....	36
4.1.1 Softkey Menu Bar .....	36
4.1.2 Menu Bar .....	38
4.1.3 Instrument Status Bar .....	38
4.2 Channel Window Layout and Functions .....	39

4.2.1	Channel Title Bar.....	40
4.2.2	Trace Status Field.....	40
4.2.3	Graph Area .....	43
4.2.4	Markers.....	44
4.2.5	Channel Status Bar.....	45
4.3	Quick Channel Setting Using Mouse .....	47
4.3.1	Active Channel Selection .....	47
4.3.2	Active Trace Selection .....	47
4.3.3	Measured Data Setting .....	47
4.3.4	Display Format Setting .....	48
4.3.5	Trace Scale Setting .....	48
4.3.6	Reference Level Setting.....	48
4.3.7	Marker Stimulus Value Setting.....	48
4.3.8	Switching between Start/Center and Stop/Span Modes .....	49
4.3.9	Start/Center Value Setting .....	49
4.3.10	Stop/Span Value Setting.....	49
4.3.11	Sweep Points Number Setting .....	49
4.3.12	Sweep Type Setting .....	49
4.3.13	IF Bandwidth Setting .....	49
4.3.14	Power Level / CW Frequency Setting .....	50
4.4	Channel and Trace Display Setting .....	51
4.4.1	Channel Window Allocating .....	51
4.4.2	Number of Traces Setting.....	52
4.4.3	Trace/Channel Activating .....	54
4.4.4	Active Channel Window Maximizing .....	54
4.5	Stimulus Setting .....	55
4.5.1	Sweep Type Setting .....	55
4.5.2	Sweep Span Setting.....	56
4.5.3	Sweep Points Setting.....	56
4.5.4	Stimulus Power Setting .....	56
4.5.5	Power Slope Feature.....	57
4.5.6	CW Frequency Setting .....	57
4.5.7	RF Out Function .....	57
4.5.8	Segment Table Editing .....	58
4.5.9	Measurement Delay.....	60
4.6	Trigger Setting .....	61
4.7	Measurement Parameters Setting .....	62
4.7.1	S-Parameters .....	62
4.7.2	S-Parameter Setting .....	63
4.7.3	Absolute Measurements.....	64
4.7.4	Absolute Measurement Setting.....	64
4.8	Format Setting .....	65
4.8.1	Rectangular Formats.....	65
4.8.2	Polar Format .....	67
4.8.3	Smith Chart Format .....	68
4.8.4	Data Format Setting .....	70
4.9	Scale Setting .....	72
4.9.1	Rectangular Scale .....	72
4.9.2	Rectangular Scale Setting.....	72
4.9.3	Circular Scale.....	73
4.9.4	Circular Scale Setting.....	73

4.9.5	Automatic Scaling.....	73
4.9.6	Reference Level Automatic Selection .....	74
4.9.7	Electrical Delay Setting.....	74
4.9.8	Phase Offset Setting.....	75
4.10	Measurement Optimizing .....	76
4.10.1	IF Bandwidth Setting .....	76
4.10.2	Averaging Setting .....	76
4.10.3	Smoothing Setting.....	77
4.10.4	Max Hold function.....	78
<b>5</b>	<b>CALIBRATION AND CALIBRATION KIT.....</b>	<b>79</b>
5.1	General Information.....	79
5.1.1	Measurement Errors .....	79
5.1.2	Systematic Errors.....	80
5.1.3	Error Modeling .....	82
5.1.4	Analyzer Test Ports Defining .....	84
5.1.5	Calibration Steps.....	85
5.1.6	Calibration Methods .....	86
5.1.7	Calibration Standards and Calibration Kits .....	88
5.2	Calibration Procedures.....	91
5.2.1	Calibration Kit Selection .....	91
5.2.2	Reflection Normalization.....	93
5.2.3	Transmission Normalization.....	95
5.2.4	Full One-Port Calibration .....	97
5.2.5	One-Path Two-Port Calibration.....	99
5.2.6	Error Correction Disabling .....	100
5.2.7	Error Correction Status .....	101
5.2.8	System Impedance $Z_0$ .....	101
5.2.9	Port Extension.....	101
5.3	Calibration Kit Management.....	103
5.3.1	Calibration Kit Selection for Editing .....	103
5.3.2	Calibration Kit Label Editing.....	103
5.3.3	Predefined Calibration Kit Restoration .....	104
5.3.4	Calibration Standard Editing .....	104
5.4	Automatic Calibration Module.....	106
5.4.1	Automatic Calibration Module Features .....	107
5.4.2	Automatic Calibration Procedure .....	108
5.4.3	Confidence Check Procedure .....	109
<b>6</b>	<b>MEASUREMENT DATA ANALYSIS.....</b>	<b>110</b>
6.1	Markers.....	110
6.1.1	Marker Adding .....	112
6.1.2	Marker Deleting .....	112
6.1.3	Marker Stimulus Value Setting.....	112
6.1.4	Marker Activating .....	113
6.1.5	Reference Marker Feature .....	114
6.1.6	Marker Properties .....	115
6.1.7	Marker Position Search Functions.....	117
6.1.8	Marker Math Functions.....	119
6.2	Memory Trace Function .....	122
6.2.1	Saving Trace into Memory.....	123

6.2.2	Memory Trace Deleting .....	123
6.2.3	Mathematical Operations.....	124
6.3	Fixture Simulation .....	125
6.3.1	Port Z Conversion .....	125
6.3.2	De-embedding .....	126
6.3.3	Embedding.....	127
6.4	Time Domain Transformation .....	129
6.4.1	Time Domain Transformation Activating .....	130
6.4.2	Time Domain Transformation Span.....	131
6.4.3	Time Domain Transformation Type .....	131
6.4.4	Time Domain Transformation Window Shape Setting.....	132
6.4.5	Frequency Harmonic Grid Setting.....	133
6.5	Time Domain Gating.....	134
6.5.1	Time Domain Gate Activating .....	135
6.5.2	Time Domain Gate Span.....	135
6.5.3	Time Domain Gate Type.....	136
6.5.4	Time Domain Gate Shape Setting.....	136
6.6	S-Parameter Conversion.....	137
6.7	Limit Test.....	139
6.7.1	Limit Line Editing.....	140
6.7.2	Limit Test Enabling/Disabling.....	141
6.7.3	Limit Test Display Management .....	141
6.7.4	Limit Line Offset .....	142
6.8	Ripple Limit Test .....	142
6.8.1	Ripple Limit Editing.....	143
6.8.2	Ripple Limit Enabling/Disabling .....	144
6.8.3	Ripple Limit Test Display Management .....	144
<b>7</b>	<b>ANALYZER DATA OUTPUT .....</b>	<b>145</b>
7.1	Analyzer State .....	145
7.1.1	Analyzer State Saving.....	146
7.1.2	Analyzer State Recalling.....	146
7.2	Trace Data CSV File.....	147
7.2.1	CSV File Saving/Recalling .....	147
7.3	Trace Data Touchstone File .....	148
7.3.1	Touchstone File Saving.....	150
7.3.2	Touchstone File Recalling.....	150
<b>8</b>	<b>SYSTEM SETTINGS .....</b>	<b>152</b>
8.1	Analyzer Presetting.....	152
8.2	Graph Printing .....	152
8.3	User Interface Setting .....	154
8.4	Reference Frequency Oscillator Selection.....	157
8.5	System Correction Setting.....	157
<b>9</b>	<b>MAINTENANCE AND STORAGE .....</b>	<b>158</b>
9.1	Maintenance Procedures .....	158

9.1.1	Instrument Cleaning .....	158
9.1.2	Factory Calibration.....	158
9.2	Storage Instructions.....	158
<b>Appendix 1 — Default Settings Table .....</b>		<b>160</b>

## INTRODUCTION

This Operating Manual contains design, specifications, functional overview, and detailed operation procedures for the Network Analyzer, to ensure effective and safe use of its technical capabilities by the user.

Maintenance and operation of the Analyzer should be performed by qualified engineers with basic experience in operating of microwave circuits and PC.

The following abbreviations are used in this Manual:

- PC – Personal Computer
- DUT – Device Under Test
- IF – Intermediate Frequency
- CW – Continuous Wave
- SWR – Standing Wave Ratio

## SAFETY INSTRUCTIONS

Carefully read the following safety instructions before putting the Analyzer into operation. Observe all the precautions and warnings provided in this Manual for all the phases of operation, service, and repair of the Analyzer.

The Analyzer should be used only by skilled and thoroughly trained personnel with the required skills and knowledge of safety precautions.

The Analyzer complies with INSTALLATION CATEGORY II as well as POLLUTION DEGREE 2 as defined in IEC61010-1.

The Analyzer is a MEASUREMENT CATEGORY I (CAT I) device. Do not use the Analyzer as a CAT II, III, or IV device.

The Analyzer is for INDOOR USE only.

The Analyzer has been tested as a stand-alone device and in combination with the accessories supplied by Copper Mountain Technologies, in accordance with the requirements of the standards described in the Declaration of Conformity. If the Analyzer is integrated with another system, compliance with related regulations and safety requirements are to be confirmed by the builder of the system.

Never operate the Analyzer in an environment containing flammable gasses or fumes.

Operators must not remove the cover or any other part of the housing. The Analyzer must not be repaired by the operator. Component replacement or internal adjustment must be performed by qualified maintenance personnel only.

Never operate the Analyzer if the power cable is damaged.

Never connect the test ports to A/C power mains.

Electrostatic discharge can damage the Analyzer whether connected to or disconnected from the DUT. Static charge can build up on your body and damage sensitive internal components of both the Analyzer and the DUT. To avoid damage from electric discharge, observe the following:

- Always use a desktop anti-static mat under the DUT.
- Always wear a grounding wrist strap connected to the desktop anti-static mat via daisy-chained 1 M $\Omega$  resistor.
- Connect the post marked  on the body of the Analyzer to the body of the DUT before you start operation.

Observe all general safety precautions related to operation of electrically energized equipment.



The definitions of safety symbols used on the instrument and in the Manual are listed below.



Refer to the Manual if the instrument is marked with this symbol.



On (Supply).



Off (Supply).



A chassis terminal; a connection to the instrument's chassis, which includes all exposed metal surfaces.

---

---

CAUTION

---

This sign denotes a hazard. It calls attention to a procedure, practice, or condition that, if not correctly performed or adhered to, could result in damage to or destruction of part or all of the instrument.

---

---

Note

---

This sign denotes important information. It calls attention to a procedure, practice, or condition that is essential for the user to understand.

# 1 GENERAL OVERVIEW

## 1.1 Description

The TR5048 and TR7530 Network Analyzers is designed for use in the process of development, adjustment and testing of various electronic devices in industrial and laboratory facilities, including operation as a component of an automated measurement system. The Analyzers is designed for operation with an external PC, which is not supplied with the Analyzers.

## 1.2 Specifications

### 1.2.1 Basic Specifications

Table 1.1 Basic Specifications

1	2
Test ports TR5048 TR7530	2 N socket ports, 50Ω 2 N socket ports, 75Ω
Frequency range TR5048 TR7530	20 kHz to 4.8 GHz 20 kHz to 3.0 GHz
CW frequency accuracy	$\pm 5 \times 10^{-6}$
Frequency setting resolution	10 Hz
Number of measurement points	2 to 200,001
Measurement bandwidth	10 Hz to 30 kHz (with 1/3 steps)
Dynamic range (IF bandwidth 10 Hz) TR5048 From 20 kHz to 300 kHz: From 300 kHz to 4.8 GHz: TR7530 From 20 kHz to 300 kHz: From 300 kHz to 3.0 GHz:	95 dB, 100 dB typical 120 dB, 123 dB typical  95 dB, 100 dB typical 120 dB, 123 dB typical

1	2
Magnitude/phase transmission measurement accuracy <sup>1</sup> , $ S_{11} $ less than $-32$ dB; $ S_{21} $ as follows: +5 dB to +10 dB -50 dB to +5 dB -70 dB to -50 dB From 20 kHz to 300 kHz: From 300 kHz to 4.8 GHz (TR5048): From 300 kHz to 3.0 GHz (TR7530): -90 dB to -70 dB From 300 kHz to 4.8 GHz (TR5048): From 300 kHz to 3.0 GHz (TR7530):	0.65 dB/3° 0.55 dB/3° 3.0 dB/12° 1.0 dB/4° 1.0 dB/4° 3.0 dB/12° 3.0 dB/12°
Magnitude/phase reflection measurement accuracy <sup>1</sup> ; $ S_{11} $ and $ S_{22} $ as follows: -15 dB to 0 dB -25 dB to -15 dB -35 dB to -25 dB	0.4 dB/3° 1.0 dB/6° 3.0 dB/20°
Trace noise (IF bandwidth 3 kHz) From 20 kHz to 300 kHz: From 300 kHz to 4.8 GHz (TR5048): From 300 kHz to 3.0 GHz (TR7530):	0.015 dB RMS 0.002 dB RMS 0.002 dB RMS
Temperature dependence (per one degree of temperature variation)	0.02 dB
Effective directivity Effective source match Effective load match	46 dB 40 dB 46 dB

<sup>1</sup> The specifications of the Analyzer apply over the temperature range of  $23\text{ °C} \pm 5\text{ °C}$  (unless otherwise specified) after 40 minutes of warming-up, with less than  $1\text{ °C}$  deviation from the 1-path two-port calibration temperature, at output power of  $-5\text{ dBm}$ , and IF bandwidth 10 Hz.

1	2
Uncorrected directivity From 300 kHz to 4.8 GHz (TR5048): From 300 kHz to 3.0 GHz (TR7530):	18 dB 18 dB
Uncorrected output port match	22 dB
Output power level	-55 dBm to +5 dBm
Output power level accuracy	±1.0 dB
Output power resolution	0.05 dB
Harmonic distortion From 300 kHz to 4.8 GHz (TR5048): From 300 kHz to 3.0 GHz (TR7530):	-20 dBc -20 dBc
Non-harmonic spurious From 300 kHz to 4.8 GHz (TR5048): From 300 kHz to 3.0 GHz (TR7530):	-30 dBc -30 dBc
Uncorrected input port match	22 dB
Damage level	23 dBm
Damage DC voltage	35 V
Receiver noise floor (IF bandwidth 10 Hz) TR5048 From 20 kHz to 300 kHz: From 300 kHz to 4.8 GHz: TR7530 From 20 kHz to 300 kHz: From 300 kHz to 3.0 GHz:	-90 dBm -115 dBm -90 dBm -115 dBm
Measurement time per point	200 μs
Source to receiver switchover time	10 ms
External frequency reference External frequency reference input level External frequency reference input impedance	10 MHz 1 dBm ± 3 dB 50 Ω

Frequency reference input/output connector type	BNC female
Output reference signal level into 50Ω	0 dBm ± 2 dB
1	2
Warm-up time, minimum	40 minutes
Power supply, external DC	9-15 V
Power consumption, external DC	10 W
Dimensions LxWxH	267x160x44 mm
Weight	1.3 kg
Operating conditions: – environmental temperature – humidity at 25 °C – atmospheric pressure	5 °C to 40 °C 90% 84 to 106.7 kPa

### 1.2.2 Measurement Capabilities

Measured parameters	$S_{11}, S_{21}$
Number of measurement channels	Up to 9 logical channels. Each logical channel is represented on the screen as an individual channel window. A logical channel is defined by such stimulus signal settings as frequency range, number of test points, power level, etc.
Data traces	Up to 8 data traces can be displayed in each channel window. A data trace represents one of the following parameters of the DUT: S-parameters, response in time domain, input power response.
Memory traces	Each of the 8 data traces can be saved into memory for further comparison with the current values.
Data display formats	Logarithmic magnitude, linear magnitude, phase, expanded phase, group delay, SWR, real part, imaginary part, Smith chart format and polar format.
<b>Sweep setup features</b>	
Sweep type	Linear frequency sweep, logarithmic frequency sweep, and segment frequency sweep, when the stimulus power is a fixed value; and linear power sweep when frequency is a fixed value.
Measured points per sweep	From 2 to 200001.
Segment sweep	A frequency sweep within several user-defined segments. Frequency range, number of sweep points, source power, and IF bandwidth should be set for each segment.
Power settings	Source power from -55 dBm to +5 dBm with resolution of 0.05 dB. In frequency sweep mode the power slope can be set to up to 2 dB/GHz to compensate high frequency attenuation in cables.
Sweep trigger	Trigger modes: continuous, single, hold.

### Trace display functions

Trace display	Data trace, memory trace, or simultaneous data and memory traces.
Trace math	Data trace modification by math operations: addition, subtraction, multiplication or division of measured complex values and memory data.
Autoscaling	Automatic selection of scale division and reference level value to have the trace most effectively displayed.
Electrical delay	Calibration plane compensation for delay in the test setup, or for electrical delay in a DUT during measurements of deviation from linear phase.
Phase offset	Phase offset in degrees.

### Accuracy enhancement

Calibration	Calibration of a test setup (which includes the Analyzer, cables, and adapters) significantly increases the accuracy of measurements. Calibration allows for correction of errors caused by imperfections in the measurement system: system directivity, source and load match, tracking and isolation.
Calibration methods	The following calibration methods of various sophistication and accuracy enhancement are available: <ul style="list-style-type: none"> <li>▪ reflection and transmission normalization;</li> <li>▪ full one-port calibration;</li> <li>▪ one-path two-port calibration.</li> </ul>
Reflection and transmission normalization	The simplest calibration method. It provides limited accuracy.
Full one-port calibration	Method of calibration performed for one-port reflection measurements. It ensures high accuracy.

One-path two-port calibration	Method of calibration performed for reflection and one-way transmission measurements, for example for measuring $S_{11}$ and $S_{21}$ only. It ensures high accuracy for reflection measurements, and reasonable accuracy for transmission measurements.
Mechanical calibration kits	The user can select one of the predefined calibration kits of various manufacturers or define additional calibration kits.
Electronic calibration modules	Copper Mountain automatic calibration modules make the Analyzer calibration faster and easier than traditional mechanical calibration.
Defining of calibration standards	Different methods of calibration standard definition are available: <ul style="list-style-type: none"> <li>▪ standard definition by polynomial model</li> <li>▪ standard definition by data (S-parameters).</li> </ul>
Error correction interpolation	When the user changes settings such as start/stop frequencies and number of sweep points, compared to the settings of calibration, interpolation or extrapolation of the calibration coefficients will be applied.

### Supplemental calibration methods

Power calibration	Method of calibration, which allows for maintaining more stable power levels at the DUT input. An external power meter should be connected to the USB port directly or via USB/GPIB adapter.
-------------------	----------------------------------------------------------------------------------------------------------------------------------------------------------------------------------------------



**Marker functions**

Data markers	Up to 16 markers for each trace. A marker indicates the stimulus value and measurement result at a given point of the trace.
Reference marker	Enables indication of any marker values as relative to the reference marker.
Marker search	Search for max, min, peak, or target values on a trace.
Marker search additional features	User-definable search range. Available as either a tracking marker, or as a one-time search.
Marker math functions	Statistics, bandwidth, flatness, RF filter.
Statistics	Calculation and display of mean, standard deviation and peak-to-peak in a frequency range limited by two markers on a trace.
Bandwidth	Determines bandwidth between cutoff frequency points for an active marker or absolute maximum. The bandwidth value, center frequency, lower frequency, higher frequency, Q value, and insertion loss are displayed.
Flatness	Displays gain, slope, and flatness between two markers on a trace.
RF filter	Displays insertion loss and peak-to-peak ripple of the passband, and the maximum signal magnitude in the stopband. The passband and stopband are defined by two pairs of markers.

**Data analysis**

Port impedance conversion	The function converts S-parameters measured at 50 $\Omega$ or 75 $\Omega$ port into values which would be found if measured at a test port with arbitrary impedance.
De-embedding	The function allows mathematical exclusion of the effects of the fixture circuit connected between the calibration plane and the DUT. This circuit should be described by an S-parameter matrix in a Touchstone file.
Embedding	The function allows mathematical simulation of the DUT parameters after virtual integration of a fixture circuit between the calibration plane and the DUT. This circuit should be described by an S-parameter matrix in a Touchstone file.
S-parameter conversion	The function allows conversion of the measured S-parameters to the following parameters: reflection impedance and admittance, transmission impedance and admittance, and inverse S-parameters.
Time domain transformation	The function performs data transformation from frequency domain into response of the DUT to various stimulus types in time domain. Modeled stimulus types: bandpass, lowpass impulse, and lowpass step. Time domain span is set by the user arbitrarily from zero to maximum, which is determined by the frequency step. Various window shapes allow optimizing the tradeoff between resolution and level of spurious sidelobes.
Time domain gating	The function mathematically removes unwanted responses in time domain, allowing for obtaining frequency response without the influence of the fixture elements. The function applies a reverse transformation back to the frequency domain from the user-defined span in the time domain. Gating filter types: bandpass or notch. For better tradeoff between gate resolution and level of spurious sidelobes the following filter shapes are available: maximum, wide, normal and minimum.

---

**Mixer / converter measurements**

Scalar mixer / converter measurements	The scalar method allows measurement of scalar transmission S-parameters of mixers and other devices having different input and output frequencies. No external mixers or other devices are required. The scalar method employs port frequency offset when there is difference between receiver frequency and source frequency.
Scalar mixer / converter calibration	Method of calibration applied for measurements of mixers in frequency offset mode. The OPEN, SHORT, and LOAD calibration standards are used. An external power meter should be connected to the USB port directly.
Automatic adjustment of frequency offset	The function performs automatic frequency offset adjustment when scalar mixer / converter measurements are performed to compensate for LO frequency inaccuracies internal to the DUT.

---

**Other features**

Familiar graphical user interface	Graphical user interface based on the Windows operating system ensures fast and easy Analyzer operation by the user.
Analyzer control	Using a personal computer.
Printout/saving of traces	The traces and data printout function has a preview feature. Previewing, saving and printing can be performed using MS Word, Image Viewer for Windows, or the Analyzer Print Wizard.

---

**Remote control**

COM/DCOM	Remote control over COM/DCOM. COM automation runs the user program on an Analyzer PC. DCOM automation runs the user program on a LAN-networked PC.
----------	----------------------------------------------------------------------------------------------------------------------------------------------------

---

## 1.3 Ordering Information

### 1.3.1 Standard Accessories

The standard accessories supplied with the Vector Network Analyzer are as follows:

- Mains Adapter                      1 pc
- USB Cable                            1 pc
- CD with software                    1 pc
- Operating Manual                    1 pc

## 1.4 Principle of Operation

The Vector Network Analyzer consists of the Analyzer Unit, some supplementary accessories, and personal computer (which is not supplied with the package). The Analyzer Unit is connected to PC via USB-interface. The block diagram of the Analyzer is represented in figure 1.1.

The Analyzer Unit consists of source oscillator, local oscillator, and source power attenuator, after which the source signal is transferred to the directional coupler, which is ending with connector of the port 1. Port 1 is the source of the test signal. The test signal from the signal source goes through the DUT to the connector of the port 2. Port 2 is the receiver of the test signal. The incident and reflected waves from the directional coupler and the signal from the receiver port 2 are supplied into the mixers, where they are converted into first IF (312.5 MHz), and are transferred further to the 3-Channel receiver. The 3-Channel receiver, after filtration, produces the signal of second IF (about 40 kHz), then digitally encodes it and supplies for further processing (filtration, phase difference estimation, magnitude measurement) into the signal processor. The filters for the second IF are digital and have pass band from 10 Hz to 30 kHz. The combination of the assemblies of directional couplers, mixers and 3-Channel receiver forms three similar signal receivers.

An external PC controls the operation of the components of the Analyzer. To fulfill the S-parameter measurement, the Analyzer supplies the source signal of the assigned frequency from port 1 to the DUT, then measures magnitude and phase of the signals transmitted and reflected by the DUT, and after that compares these results to the magnitude and phase of the source signal.

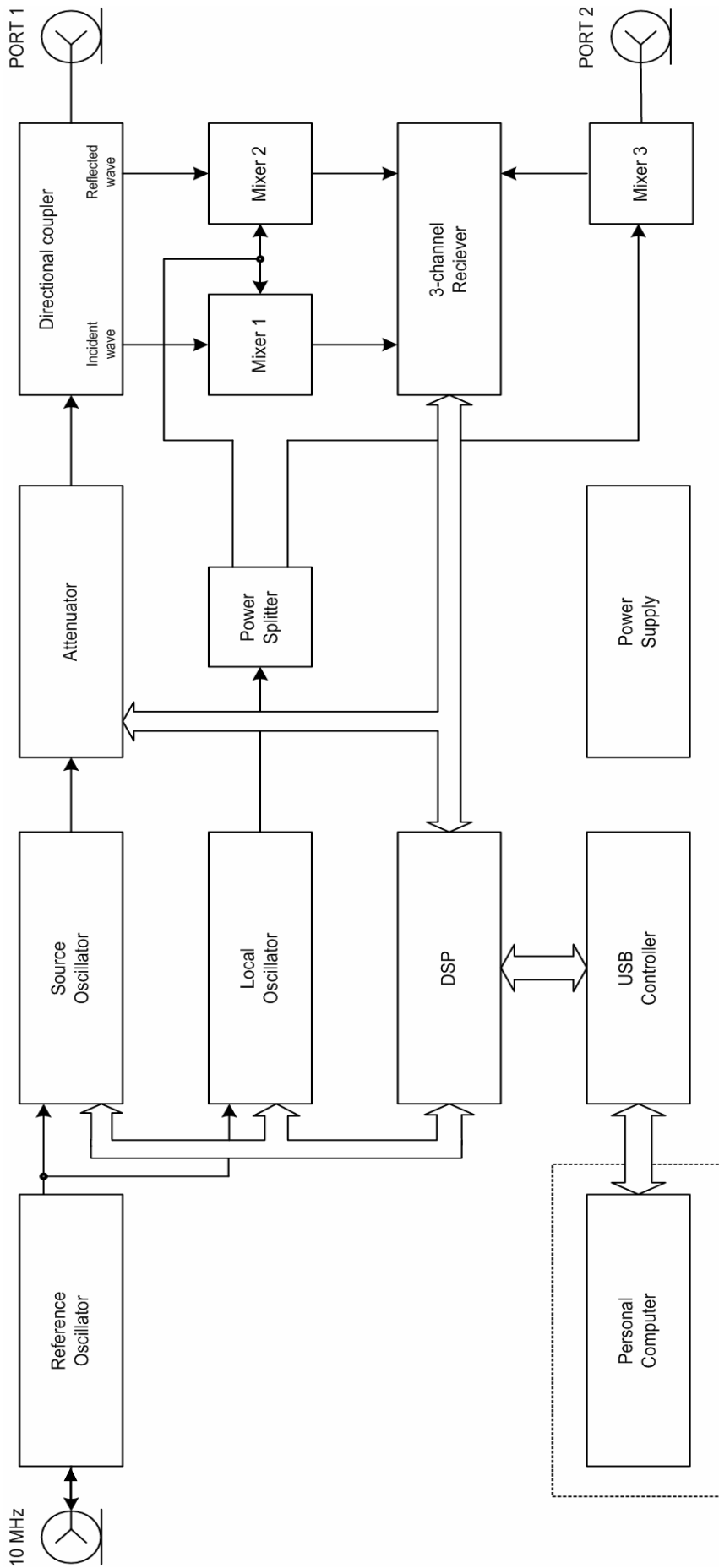

Figure 1.1 Vector Network Analyzer block diagram

## 2 PREPARATION FOR USE

### 2.1 General Information

Unpack the Analyzer and other accessories. Check the contents of the package against the list specified in section 1.3.1. Connect the earth terminal to the earth protection. Then connect your Analyzer to power source by means of the Mains Adapter supplied with the instrument. Connect the USB-port of your Analyzer to the PC using the USB Cable supplied in the package. Install the software (supplied on the USB Flash Drive) onto your PC. The software installation procedure is described below in section 2.2.

Warm-up the Analyzer for 40 minutes after power-on.

Assemble the test setup using cables, connectors, fixtures, etc, which allow DUT connection to the Analyzer.

Perform calibration of the Analyzer. Calibration procedure is described in section 5.

### 2.2 Software Installation

Connect the Analyzer to your PC via USB interface and install the software using the USB Flash Drive supplied with the instrument.

---

Minimal system requirements for the PC	WINDOWS 2000/XP/VISTA/7/8 1.5 GHz Processor 2 GB RAM USB 2.0 High Speed
----------------------------------------	----------------------------------------------------------------------------------

---

The supplied USB Flash Drive contains the following software.

---

CD contents	<b>Setup_TR5048_vX.X.exe</b> <sup>1</sup> , or <b>Setup_TR7530_vX.X.exe</b> installer file folder <b>Driver</b> contains the driver folder <b>Doc</b> contains documentation
-------------	---------------------------------------------------------------------------------------------------------------------------------------------------------------------------------------

---

<sup>1</sup> X.X – program version number

The procedure of the software installation is broken up into two steps. The first one is the driver installation. The second step comprises installation of the program, documentation and other files.

---

Driver installation	<p>Connect the Analyzer to your PC via the supplied USB cable. It is allowed to connect the USB cable to the running PC.</p> <p>Turn on and boot the PC, if it is off.</p> <p>Turn the Analyzer on by the Power key on the rear panel.</p> <p>When you connect the Analyzer to the PC for the first time, Windows will automatically detect the new USB device and will open the USB driver installation dialog (Windows 2000/XP/VISTA). In Windows 7, open the USB driver installation dialog as follows: <b>Start &gt; Control Panel &gt; Device Manager</b>. Make the right mouse click on the <i>Unknown Device</i> line and select <b>Update Drivers</b>.</p> <p>In the USB driver installation dialog, click on <b>Browse</b> and specify the path to the driver files, which are contained in the \DRIVER folder on the CD and on hard drive in analyzer software folder.</p> <p>When the driver is installed, the new USB device (TR5048 Network Analyzer or TR7530 Network Analyzer) will appear in the system.</p>
Program and other files installation	<p>Run the <b>Setup_TR5048_vX.X.exe</b> or <b>Setup_TR7530_vX.X.exe</b> installer file from the CD. Follow the instructions of the installation wizard.</p>

---

## 2.3 Front Panel

The front view of Analyzer is represented in figure 2.1. The front panel is equipped with the following parts:

- Test ports ;
- Power Switch;
- Indicator LEDs.

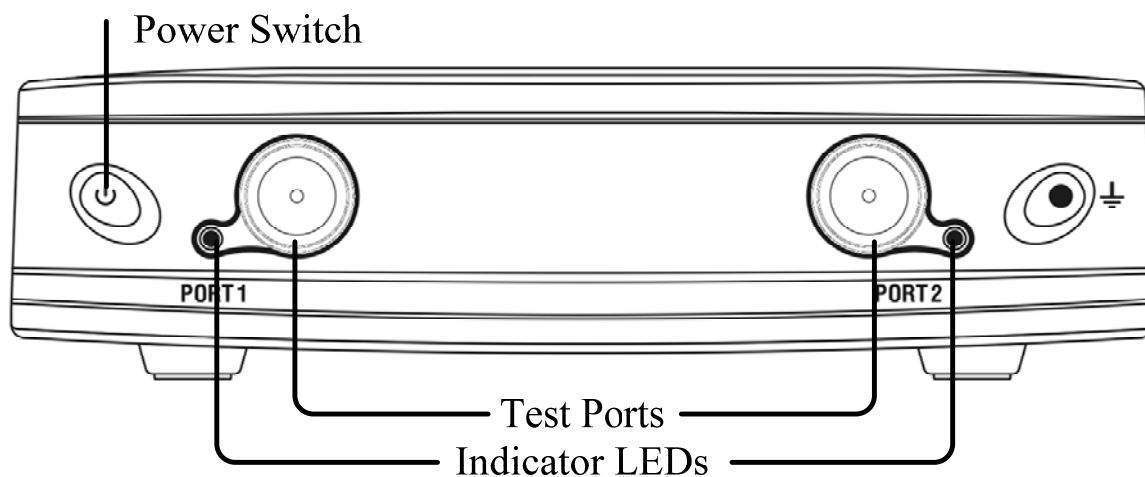

Figure 2.1 Analyzer front panel

### 2.3.1 Test Ports



The type-N 50  $\Omega$  (type-N 75  $\Omega$ ) test port 1 and test port 2 are intended for DUT connection. As the test port 1 is used as a source of the stimulus signal and the test port 2 is used as a receiver of the response signal of the DUT.

If you connect the DUT to test port 1 of the Analyzer, you will be able to measure the reflection parameter  $S_{11}$  of the DUT.

If you connect the DUT to the both test ports of the Analyzer, you will be able to measure  $S_{11}$  and  $S_{21}$  of the DUT.

#### CAUTION

Do not exceed the maximum allowed power of the input RF signal (or maximum DC voltage) indicated on the front panel. This may damage your Analyzer.



### 2.3.2 Power Switch



Switches the power supply of the Analyzer on and off.

You can turn your Analyzer on/off at any time. After power-on of the Analyzer connected to PC, the program will begin uploading embedded firmware into the instrument. The uploading process will take 10 sec.; after that the Analyzer will be ready for operation.

---

#### Note

When you turn on your Analyzer for the first time, the USB driver will be installed onto the PC. The driver installation procedure is described in section 2.2. Some computers may require re-installation of the driver in case of change of the USB port.

---

## 2.4 Rear Panel

The rear view of the Analyzer is shown in figure 2.2. Descriptions of the elements of the rear panel is provided below the figure:

- Power cable receptacle;
- External Reference Frequency connector;
- External Trigger;
- USB port;
- Earth terminal.

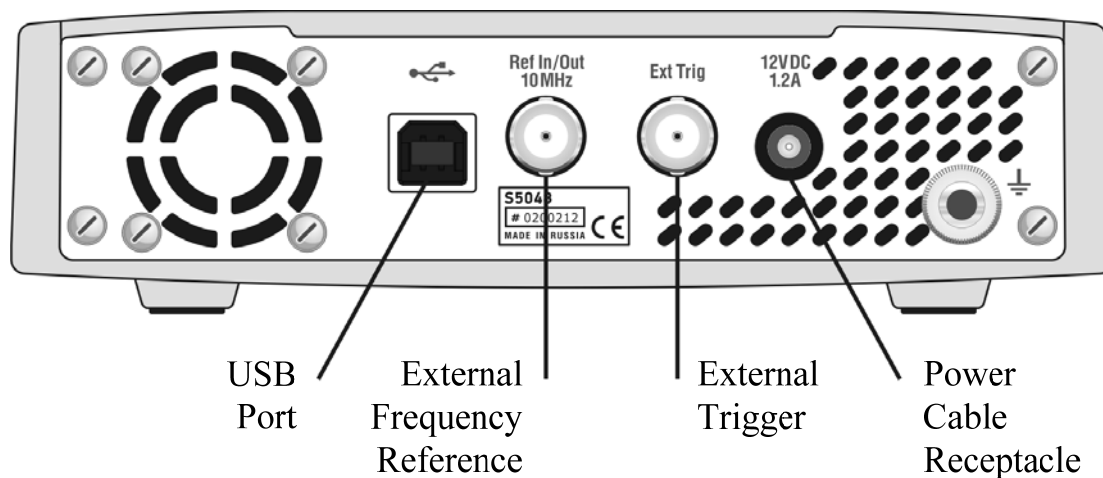

Figure 2.2 Analyzer rear panel

### 2.4.1 Power Cable Receptacle

---

Please connect an external DC power supply voltage from 9 to 15 V. The power supply can be powered by a battery, including a vehicle battery, through an appropriate vehicle power cable.

---

#### CAUTION

In case of emergency, to avoid danger of electric shock or the like, pull the power cable receptacle of the instrument.

### 2.4.2 External Trigger Signal Input Connector

---

This connector allows the user to connect an external trigger source. Connector type is BNC female. TTL compatible inputs of 3 V to 5 V magnitude have up to 1  $\mu$ s pulse width. Input impedance at least 10 k $\Omega$ .

---

### 2.4.3 External Reference Frequency Connector

---

External reference frequency is 10 MHz, input level is 2 dBm  $\pm$  3 dB, input impedance 50  $\Omega$ . Output reference signal level is 3 dBm  $\pm$  2 dB into 50  $\Omega$  impedance. Connector type is BNC female.

---

### 2.4.4 USB 2.0 High Speed

---

The USB port is intended for connection to computer.

---

### 2.4.5 Earth Terminal

---

The earth terminal is used for connection of the Analyzer housing to the housing of the DUT and the protecting grounding.

---

### 3 GETTING STARTED

This section represents a sample session of the Analyzer. It describes the main techniques of measurement of reflection coefficient parameters of the DUT. SWR and reflection coefficient phase of the DUT will be analyzed.

For reflection coefficient measurement only one test port of the Analyzer is used. The instrument sends the stimulus to the input of the DUT and then receives the reflected wave. Generally in the process of this measurement the output of the DUT should be terminated with a LOAD standard. The results of these measurements can be represented in various formats.

Typical circuit of reflection coefficient measurement is shown in figure 3.1.

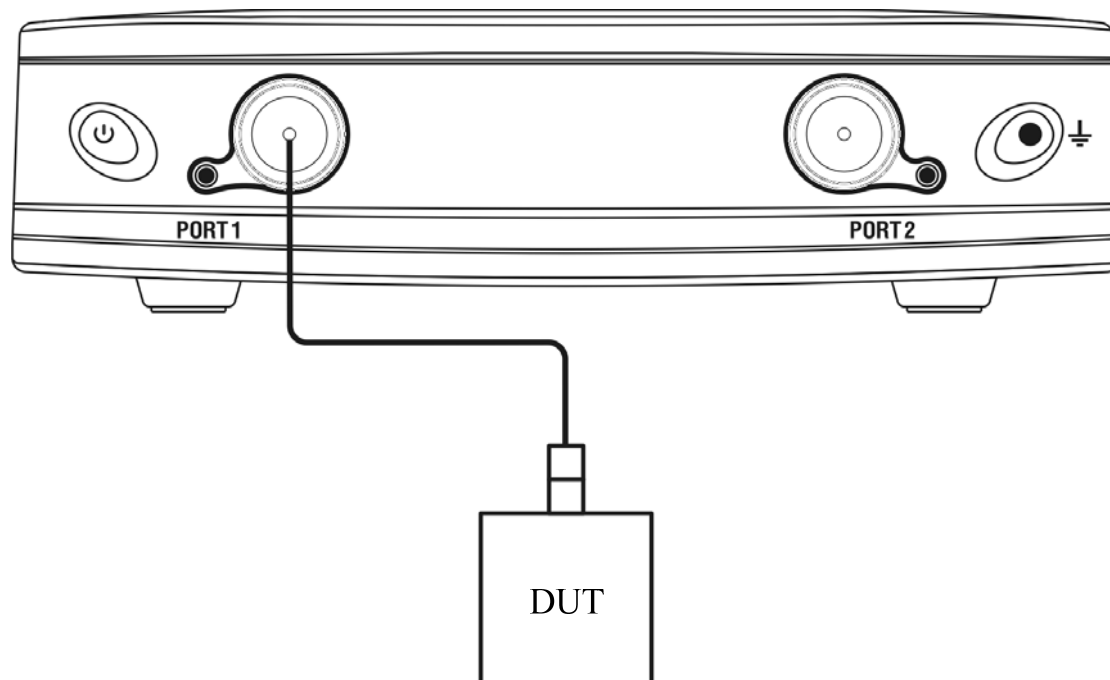

Figure 3.1 Reflection measurement circuit

To measure SWR and reflection coefficient phases of the DUT, in the given example you should go through the following steps:

- Prepare the Analyzer for reflection measurement;
- Set stimulus parameters (frequency range, number of sweep points);
- Set IF bandwidth;
- Set the number of traces to 2, assign measured parameters and display format to the traces;
- Set the scale of the traces;

- Perform calibration of the Analyzer for reflection coefficient measurement;
- Analyze SWR and reflection coefficient phase using markers.

---

Note	In this section the control over Analyzer is performed by the softkeys located in the right-hand part of the screen.
------	----------------------------------------------------------------------------------------------------------------------

---

### 3.1 Analyzer Preparation for Reflection Measurement

Turn on the Analyzer and warm it up for the period of time stated in the specifications.

---

Ready state features	The bottom line of the screen displays the instrument status bar. It should read <b>Ready</b> .
----------------------	-------------------------------------------------------------------------------------------------

---

Connect the DUT to Port 1 of the Analyzer. Use the appropriate cables and adapters for connection of the DUT input to the Analyzer test port. If the DUT input is type-N (male), you can connect the DUT directly to the port.

### 3.2 Analyzer Presetting

Before you start the measurement session, it is recommended to reset the Analyzer into the initial (known) condition. The initial condition setting is described in Appendix 1.



To restore the initial condition of the Analyzer, use the following softkeys:

**System > Preset > Apply**

### 3.3 Stimulus Setting

After you have restored the preset state of the Analyzer, the stimulus parameters will be as follows: frequency range from 20 kHz to 4.8 GHz in the case of TR5048 or frequency range from 20 kHz to 3.0 GHz in the case of TR7530. The preset sweep type is linear, number of sweep points is 201, and power level is 0 dBm.

For the current example, set the frequency range to from 10 MHz to 1 GHz.

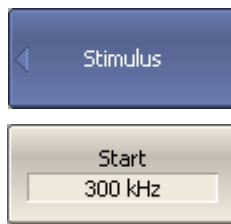

To set the start frequency of the frequency range to 10 MHz, use the following softkeys:

**Stimulus > Start**

Then enter «1», «0», «M» from the keyboard. Complete the setting by pressing «Enter» key.

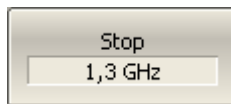

To set the stop frequency of the frequency range to 1 GHz, use the following softkeys:

**Stimulus > Stop**

Then enter «1», «G» from the keyboard. Complete the setting by pressing «Enter» key.

To return to the main menu, click the top softkey (colored in blue).

### 3.4 IF Bandwidth Setting

For the current example, set the IF bandwidth to 3 kHz.

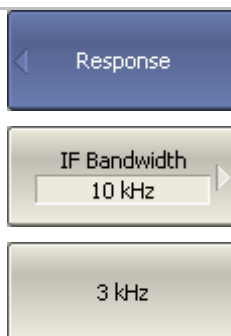

To set the IF bandwidth to 3 kHz, use the following softkeys:

**Response > IF Bandwidth > 3 kHz**

To return to the main menu, click the top softkey (colored in blue).

### 3.5 Number of Traces, Measured Parameter and Display Format Setting

In the current example, two traces are used for simultaneous display of the two parameters (SWR and reflection coefficient phase).



To add the second trace, use the following softkeys:

**Trace > Add trace**

To return to the main menu, click the top softkey (colored in blue).

Before assigning the measurement parameters of a trace, first activate the trace.



To activate the first trace, use the following softkeys:

**Trace > Active Trace > 1**

To return to the main menu, click the top softkey (colored in blue).

Assign  $S_{11}$  parameter to the second trace. To the first trace this parameter is already assigned by default.

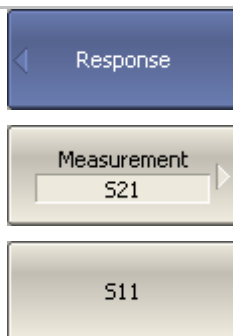

To assign a parameter to the trace, use the following softkeys:

**Response > Measurement > S11**

Then assign SWR display format to the first trace and reflection coefficient phase display format to the second trace.

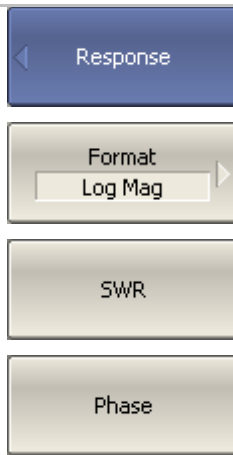

To set the active trace display format, use the following softkeys:

**Response > Format > SWR** (for the first trace),

**Response > Format > Phase** (for the second trace).

---



To return to the main menu, click the top softkey (colored in blue).

---

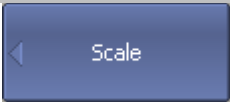

### 3.6 Trace Scale Setting

For a convenience in operation, change the trace scale using automatic scaling function.

	<p>To set the scale of the active trace by the autoscaling function, use the following softkeys:</p>
	<p><b>Scale &gt; Auto Scale</b></p>
<p>To return to the main menu, click the top softkey (colored in blue).</p>	

### 3.7 Analyzer Calibration for Reflection Coefficient Measurement

Calibration of the whole measurement setup, which includes the Analyzer, cables and other devices, supporting connection to the DUT, allows to considerably enhance the accuracy of the measurement.

To perform full 1-port calibration, you need to prepare the kit of calibration standards: OPEN, SHORT and LOAD. Such a kit has its description and specifications of the standards. To perform proper calibration, you need to select in the program the correct kit type.

In the process of full 1-port calibration, connect calibration standards to the test port one after another, as shown in figure 3.2.

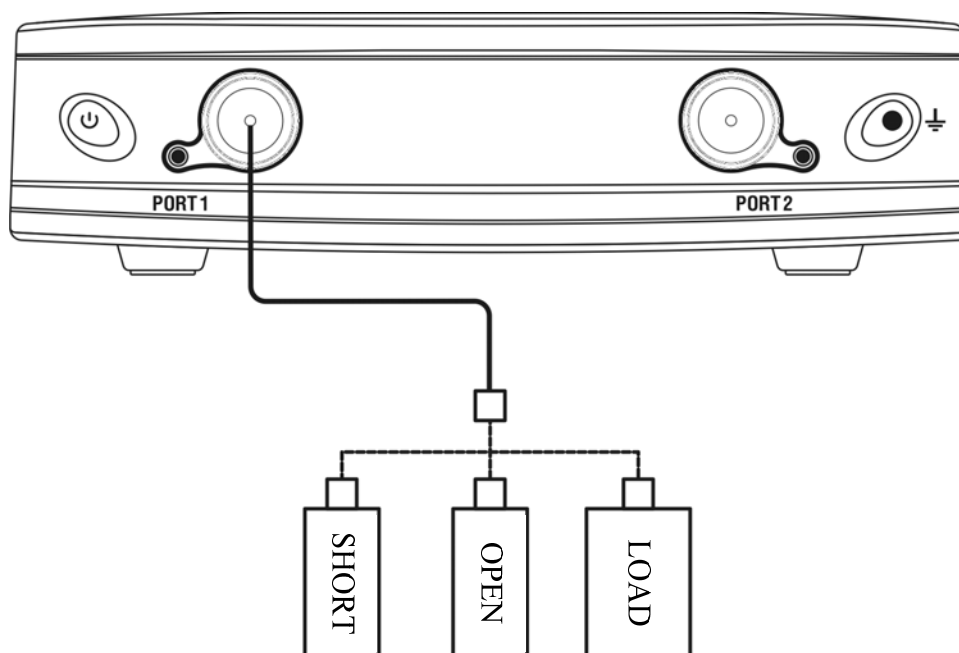

Figure 3.2 Full 1-port calibration circuit

In the current example Agilent 85032E calibration kit is used.



To select the calibration kit, use the following softkeys:

**Calibration > Cal Kit**

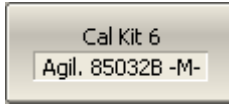

Then select the required kit from the table in the bottom of the screen.

To perform full 1-port calibration, execute measurements of the three standards. After that the table of calibration coefficients will be calculated and saved into the memory of the Analyzer. Before you start calibration, disconnect the DUT from the Analyzer.



To perform full 1-port calibration, use the following softkeys:

**Calibration > Full 1-Port Cal**

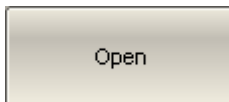

Connect an OPEN standard and click **Open**.

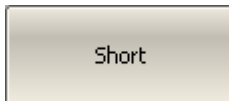

Connect a SHORT standard and click **Short**.

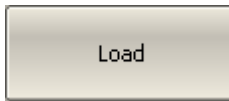

Connect a LOAD standard and click **Load**.



To complete the calibration procedure and calculate the table of calibration coefficients, click **Apply** softkey.

Then connect the DUT to the Analyzer port again.

### 3.8 SWR and Reflection Coefficient Phase Analysis Using Markers

This section describes how to determine the measurement values at three frequency points using markers. The Analyzer screen view is shown in figure 3.3. In the current example, a reflection standard of SWR = 1.2 is used as a DUT.

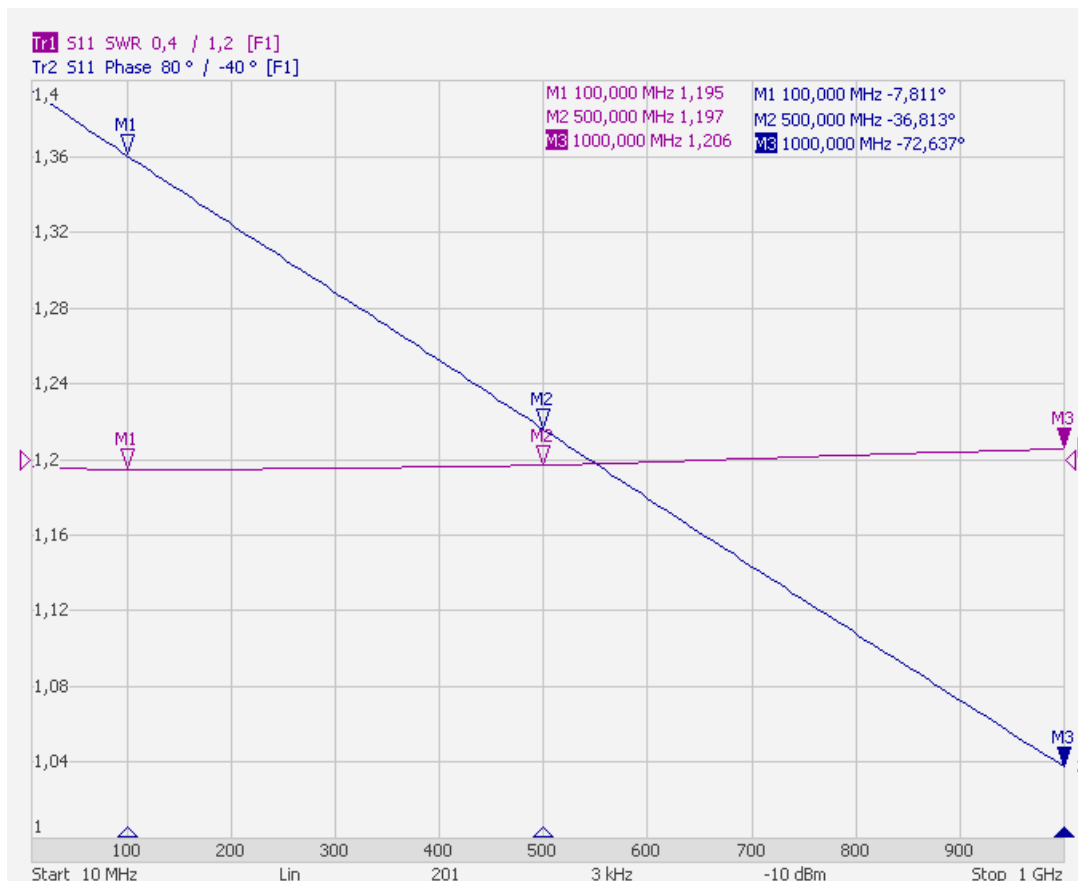

Figure 3.3 SWR and reflection coefficient phase measurement example



To enable a new marker, use the following softkeys:

**Markers > Add Marker**

Then enter the frequency value, e.g. to enter frequency 100 MHz, press «1», «0», «0», «M» and «Enter» keys on the keyboard.

Repeat the above procedure three times to enable three markers in different frequency points.

## 4 MEASUREMENT CONDITIONS SETTING

### 4.1 Screen Layout and Functions

The screen layout is represented in figure 4.1. In this section you will find detailed description of the softkey menu bar, menu bar, and instrument status bar. The channel windows will be described in the following section.

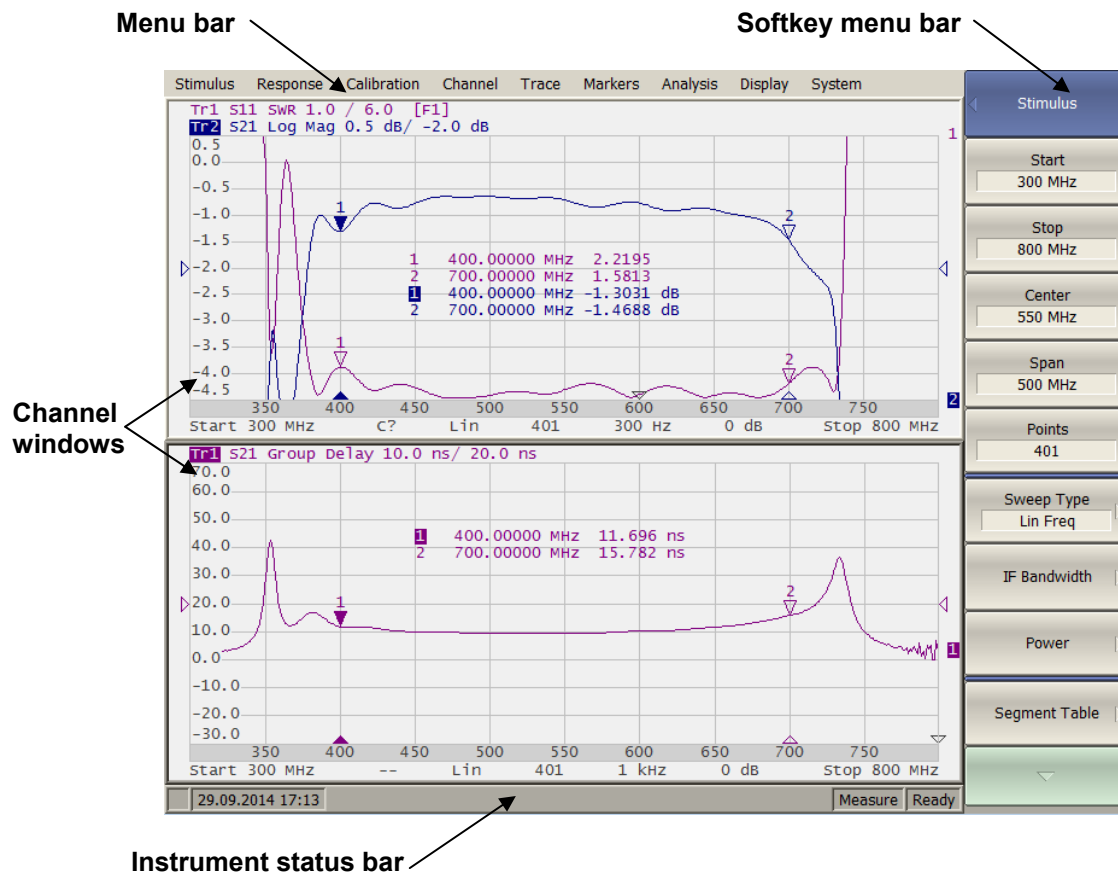

Figure 4.1 Analyzer screen layout

#### 4.1.1 Softkey Menu Bar

The softkey menu bar in the right-hand side of the screen is the main menu of the program.

---

Note The top line of the screen represents the menu bar, which enables you direct access to the submenus of the softkey menu.









---

The softkey menu bar consists of panels, which appear one instead of the other. Each panel represents one of the submenus of the softkey menu. All the panels are integrated into multilevel menu system and allow access to all the functions of the Analyzer.

You can manipulate the menu softkeys using a mouse.

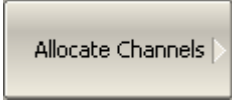
Also you can navigate the menu by «Up arrow», «Down arrow», «Left arrow», «Right arrow», «Enter», «Esc», «Space» keys on the external keyboard.

The types of the softkeys are described below:

	The top softkey is the menu title key. It enables you to return to the upper level of the menu. If it is displayed in blue you can use keyboard to navigate within the softkey menu.
	If the softkey is highlighted in dark gray, pressing «Enter» key on the keyboard will activate the function of this softkey. You can shift the highlight from key to key using «Up arrow» and «Down arrow» arrows on the keyboard.
	A large dot on the softkey indicates the current selection in a list of alternative settings.
	A check mark in the left part of the softkey indicates the active function, which you can switch on/off.
	The softkey with a right arrow enables the access to the lower level of the menu.
	The softkey with a text field allows for the selected function indication.
	The softkey with a value field allows for entering/selection of the numerical settings.
	This navigation softkey appears when the softkey menu overflows the menu screen area. Using this softkey you can scroll down and up the softkey menu.

To navigate in the softkey menu, you can also (additionally to «Up arrow », «Down arrow») use «Left arrow», «Right arrow», «Esc», «Home» keys of the keyboard:

- «Left arrow» key brings up the upper level of the menu;
- «Right arrow» key brings up the lower level of the menu, if there is a highlighted softkey with a right arrow;
- «Esc» key functions similar to «Left arrow» key;
- «Space» key is similar to «Enter» key.

Note The above keys of the keyboard allow navigation in the softkey menu only if there is no any active entry field. In this case the menu title softkey is highlighted in blue.

#### 4.1.2 Menu Bar

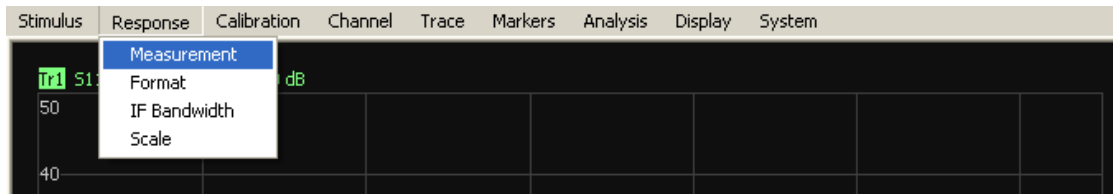

Figure 4.2 Menu bar

The menu bar is located at the top of the screen. This menu is an auxiliary one and enables you direct access to the submenus of the main menu. Also it contains the functions of the most frequently used softkeys. You can hide the menu bar to gain more screen space for the graph area. The menu bar is controlled by the mouse.

#### 4.1.3 Instrument Status Bar



Figure 4.3 Instrument status bar

The instrument status bar is located at the bottom of the screen.

Table 4.1 Messages in the instrument status bar

Field Description	Message	Instrument Status
DSP status	<b>Not Ready</b>	No communication between DSP and computer.
	<b>Loading</b>	DSP program is loading.
	<b>Ready</b>	DSP is running normally.
Sweep status	<b>Measure</b>	A sweep is in progress.
	<b>Hold</b>	A sweep is on hold.
RF signal	<b>RF Off</b>	Stimulus signal output is turned off.
Factory calibration error	<b>Power Failure</b>	ROM error of power calibration.
	<b>System Cal Failure</b>	ROM error of system calibration.

## 4.2 Channel Window Layout and Functions

The channel windows display the measurement results in the form of traces and numerical values. The screen can display up to 4 channel windows simultaneously. Each window has the following parameters:

- Frequency range;
- Sweep type;
- Number of points;
- IF bandwidth;
- Power level.

---

Note	The calibration parameters are applied to the whole Analyzer and affect all the channel windows.
------	--------------------------------------------------------------------------------------------------

---

Physical analyzer processes the logical channels in succession.

In turn each channel window can display up to 8 traces of the measured parameters. General view of the channel window is represented in figure 4.4.

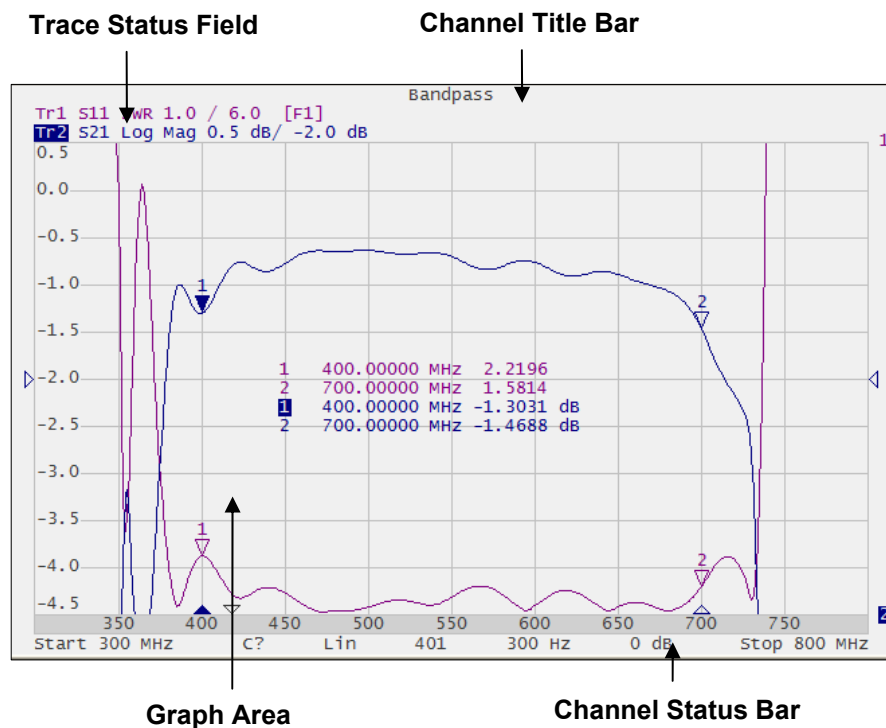

Figure 4.4 Channel window

### 4.2.1 Channel Title Bar

The channel title feature allows you to enter your comment for each channel window.

Channel title bar on/off switching	To show/hide the channel title bar, use the following softkeys:  <b>Display &gt; Title Label</b>
Note	You can also make it by mouse clicking on the title area in the channel title bar.

### 4.2.2 Trace Status Field

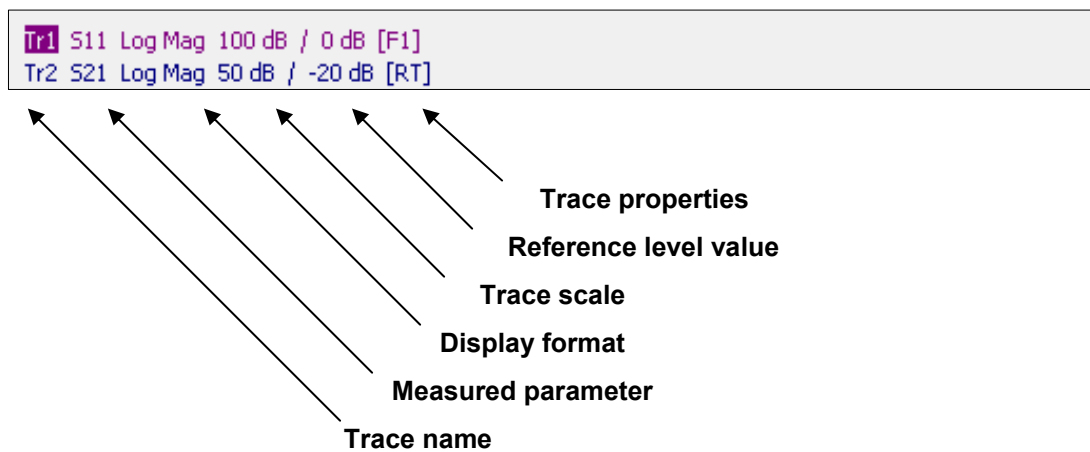

Figure 4.5 Trace status field

The trace status field displays the name and parameters of a trace. The number of lines in the field depends on the number of active traces in the channel.

Note	Using the trace status field you can easily modify the trace parameters by the mouse (as described in section 4.3).
------	---------------------------------------------------------------------------------------------------------------------



Each line contains the data on one trace of the channel:

- Trace name from «Tr1» to «Tr8». The active trace name is highlighted in inverted color;
- Measured parameter: **S11**, **S21** or absolute power value: **Abs A**, **Abs B**, **Abs R**;
- Display format, e.g. «**Log Mag**»;
- Trace scale in measurement units per scale division, e.g. «**10.0 dB/**»;
- Reference level value, e.g. «**0 dB**»;
- Trace status is indicated as symbols in square brackets (See table 4.2).

Table 4.2 Trace status symbols definition

Status	Symbols	Definition
Error Correction	<b>RO</b>	OPEN response calibration
	<b>RS</b>	SHORT response calibration
	<b>RT</b>	THRU response calibration
	<b>OP</b>	One-path 2-port calibration
	<b>F1</b>	Full 1-port calibration
Data Analysis	<b>Zo</b>	Port impedance conversion
	<b>Emb</b>	Fixture embedding
	<b>Dmb</b>	Fixture de-embedding
	<b>Pxt</b>	Port extension
Math Operations	<b>D+M</b>	Data + Memory
	<b>D-M</b>	Data - Memory
	<b>D*M</b>	Data * Memory
	<b>D/M</b>	Data / Memory
Maximum Hold	<b>Max</b>	Hold of the trace maximum between repeated measurements
Electrical Delay	<b>Del</b>	Electrical delay other than zero
Phase Offset	<b>PhO</b>	Phase offset value other than zero
Smoothing	<b>Smo</b>	Trace smoothing
Gating	<b>Gat</b>	Time domain gating
Conversion	<b>Zr</b>	Reflection impedance
	<b>Zt</b>	Transmission impedance
	<b>Yr</b>	Reflection admittance
	<b>Yt</b>	Transmission admittance
	<b>1/S</b>	S-parameter inversion
	<b>Conj</b>	Conjugation

### 4.2.3 Graph Area

The graph area displays the traces and numeric data.

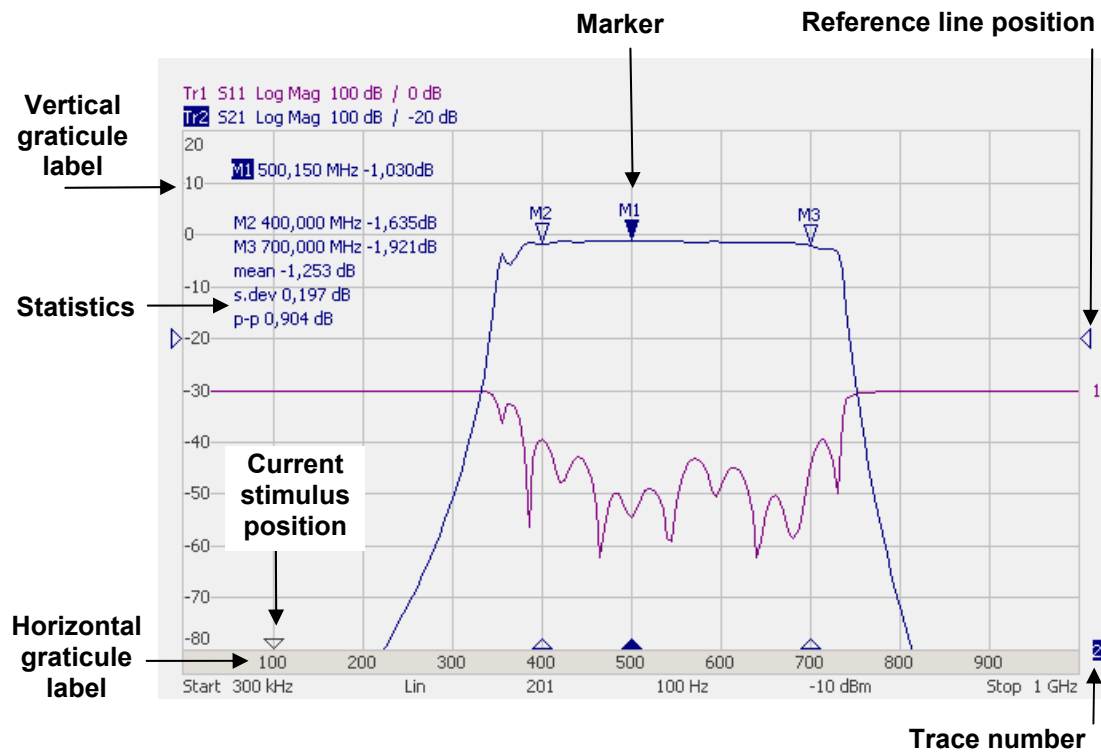

Figure 4.6 Graph area

The graph area contains the following elements:

- *Vertical graticule label* displays the vertical axis numeric data for the active trace. You can set the display of the data for all the traces or hide the vertical graticule label to gain more screen space for the trace display.
- *Horizontal graticule label* displays stimulus axis numeric data (frequency, power level or time). You can also hide the horizontal graticule label to gain more screen space for the trace display.
- *Reference level position* indicates the reference level position of the trace.
- *Markers* indicate the measured values in different points on the active trace. You can enable display of the markers for all the traces simultaneously.
- Marker functions: *statistics, bandwidth, flatness, RF filter*.
- *Trace number* allows trace identification when printed out in black and white.
- *Current stimulus position* indication appears when sweep duration exceeds 1 sec.

Note	Using the graticule labels, you can easily modify all the trace parameters by the mouse (as described in section 4.3).
------	------------------------------------------------------------------------------------------------------------------------

#### 4.2.4 Markers

The markers indicate the stimulus values and the measured values in selected points of the trace (See figure 4.7).

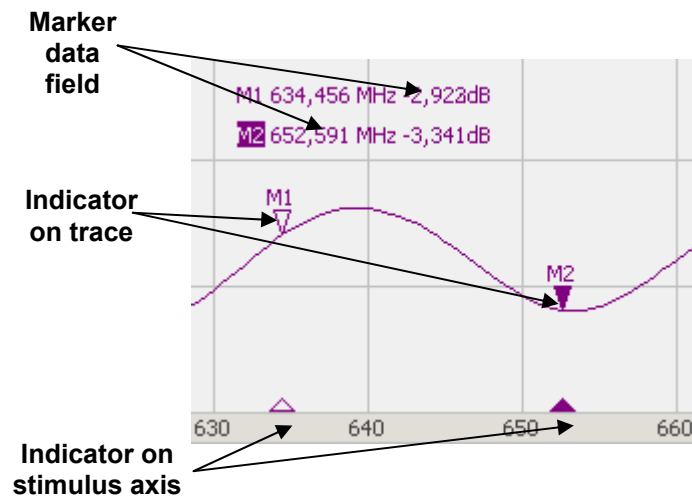

Figure 4.7 Markers

The markers are numbered from 1 to 15. The reference marker is indicated with R symbol. The active marker is indicated in the following manner: its number is highlighted in inverse color, the stimulus indicator is fully colored.

#### 4.2.5 Channel Status Bar

The channel status bar is located in the bottom part of the channel window. It contains the following elements:

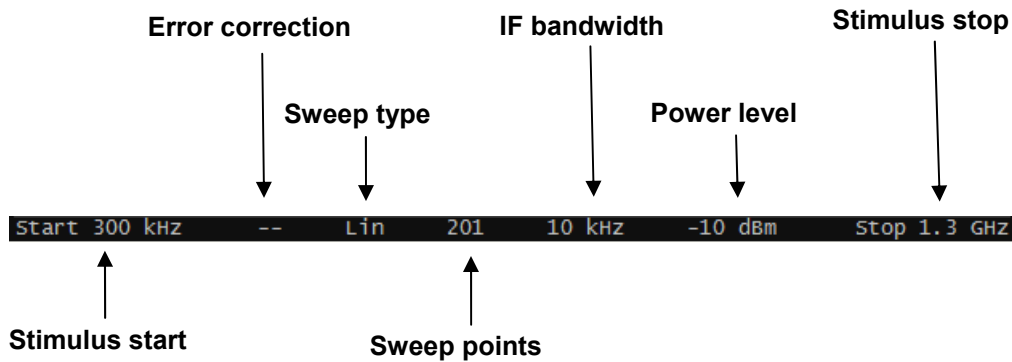

Figure 4.8 Channel status bar

- *Stimulus start* field allows for display and entry of the start frequency or power, depending on the sweep type. This field can be switched to indication of stimulus center frequency, in this case the word **Start** will change to **Center**.
- *Sweep points* field allows for display and entry of the number of sweep points. The number of sweep points can be set from 2 to 16001.
- *Sweep type* field allows for display and selection of the sweep type. The values of this field are represented in table 4.3.
- *IF bandwidth* field allows for display and setting of the IF bandwidth. The values can be set from 10 Hz to 30 kHz.
- *Power level* field allows for display and entry of the port output power. In power sweep mode the field switches to indication of CW frequency of the source.
- *Stimulus stop* field allows for display and entry of the stop frequency or power, depending on the sweep type. This field can be switched to indication of stimulus span, in this case the word **Stop** will change to **Span**.
- *Error correction* field displays the integrated status of error correction for S-parameter traces. The values of this field are represented in table 4.4

Table 4.3 Sweep types

Symbol	Definition
<b>Lin</b>	Linear frequency sweep.
<b>Log</b>	Logarithmic frequency sweep.
<b>Seg</b>	Segment frequency sweep.
<b>Pow</b>	Power sweep.

Table 4.4 Error correction field

Symbol	Definition
--	No calibration data. No calibration was performed.
<b>Cor</b>	Error correction is enabled. The stimulus settings are the same for the measurement and the calibration.
<b>C?</b>	Error correction is enabled. The stimulus settings are not the same for the measurement and the calibration. Interpolation is applied.
<b>C!</b>	Error correction is enabled. The stimulus settings are not the same for the measurement and the calibration. Extrapolation is applied.
<b>Off</b>	Error correction is turned off.

### 4.3 Quick Channel Setting Using Mouse

This section describes the mouse manipulations, which will enable you to set the channel parameters fast and easy. In a channel window, over the field where a channel parameter can be modified, the mouse pointer will change its form to indicate the edit mode. Apart from that in text and numerical fields the edit mode will be indicated by the «underline» symbol appearance.

Note

The mouse manipulations described in this section will help you to perform the most frequently used settings only. All the channel functions can be accessed via the softkey menu.

#### 4.3.1 Active Channel Selection

You can select the active channel when two or more channel windows are open. The border line of the active window will be highlighted in light color. To activate another window, make a mouse click within its area.

#### 4.3.2 Active Trace Selection

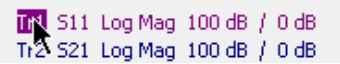

You can select the active trace if the active channel window contains two or more traces. The active trace name will be highlighted in inverted color. To activate a trace, make a mouse click on the required trace status line.

#### 4.3.3 Measured Data Setting

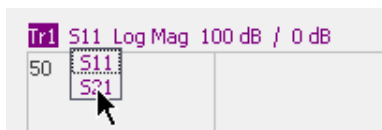

To assign the measured parameters ( $S_{11}$ ,  $S_{21}$  or Abs A, Abs B, Abs R) to a trace, make a mouse click on the S-parameter name in the trace status line and select the required parameter in the drop-down menu.

#### 4.3.4 Display Format Setting

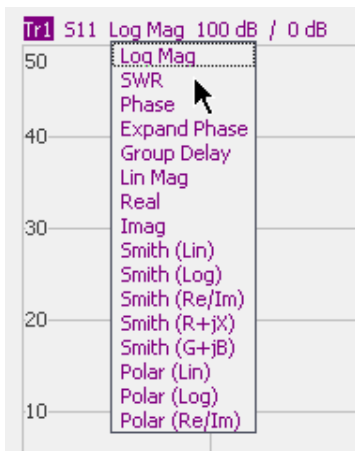

To select the trace display format, make a mouse click on the display format name in the trace status line and select the required format in the drop-down menu.

#### 4.3.5 Trace Scale Setting



numerical value.

To the trace scale, make a mouse click on the trace scale field in the trace status line and enter the required

#### 4.3.6 Reference Level Setting



enter the required numerical value. set by two methods.

To set the value of the reference level, make a mouse click on the reference level field in the trace status line and

#### 4.3.7 Marker Stimulus Value Setting

The marker stimulus value can be set by drag operation or by entering the value using numerical keys of the keyboard.

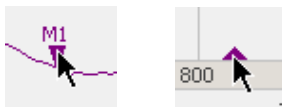

To drag the marker, move the mouse pointer on one of the marker indicators.



To enter the numerical value of the stimulus, first activate its field in the marker data line by a mouse click.



#### 4.3.8 Switching between Start/Center and Stop/Span Modes



To switch between the modes Start/Center and Stop/Span, make a mouse click in the respective field of the channel status bar. Label **Start** will be changed with **Center**, and label **Stop** will be changed with **Span**. The layout of the stimulus scale will be changed correspondingly.

#### 4.3.9 Start/Center Value Setting

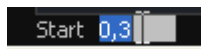

To enter the **Start/Center** values, activate the respective field in the channel status bar by a mouse click on the numerical value.

#### 4.3.10 Stop/Span Value Setting



To enter the **Stop/Span** values, activate the respective field in the channel status bar by a mouse click on the numerical value.

#### 4.3.11 Sweep Points Number Setting

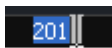

To enter the number of sweep points, activate the respective field in the channel status bar by a mouse click on the numerical value.



To select the number of points from the drop-down menu, make the right mouse click on the point number field in the channel status bar.

#### 4.3.12 Sweep Type Setting



To set the sweep type, click on the respective field in the channel status bar and select the required type in the drop-down menu.

#### 4.3.13 IF Bandwidth Setting

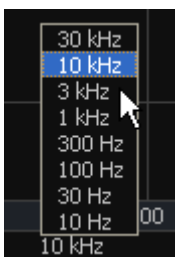

To set the IF bandwidth, make a right mouse click on the IF bandwidth field in the channel status bar. Then select the value in the drop-down menu.

#### 4.3.14 Power Level / CW Frequency Setting



To enter the **Power Level/CW Frequency**, activate the respective field in the channel status bar by a mouse click on the numerical value. The parameter displayed in the field depends on the current sweep type: in frequency sweep mode you can enter power level value, in power sweep mode you can enter CW frequency value.



To select the power level value from the drop-down menu, make a right mouse click on the **Power Level/CW Frequency** field in the channel status bar. This menu is available on in frequency sweep mode.

## 4.4 Channel and Trace Display Setting

The Analyzer supports 4 channels, which allow measurements with different stimulus parameter settings. The parameters related to a logical channel are listed in table 4.4.

### 4.4.1 Channel Window Allocating

A channel is represented on the screen as an individual channel window. The screen can display from 1 to 4 channel windows simultaneously. By default one channel window opens. If you need to open two or more channel windows select one of the layouts shown below.

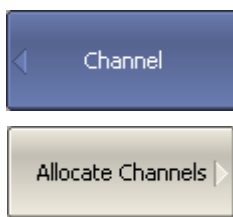

To set the channel window layout, use the following softkeys:

**Channel > Allocate Channels**

Then select the required number and layout of the channel windows in the menu.

The available options of number and layout of the channel windows on the screen are as follows:

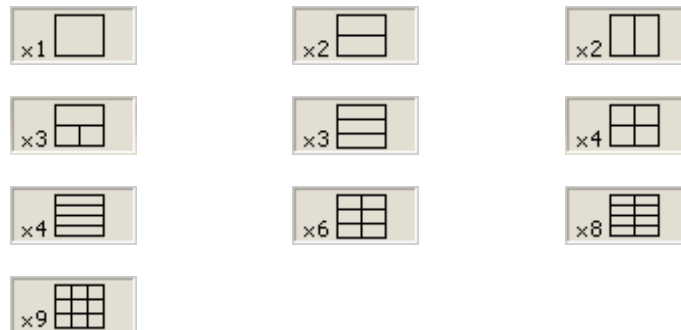

In accordance with the layouts, the channel windows do not overlap each other. The channels open starting from the smaller numbers.

#### Note

For each open channel window, you should set the stimulus parameters, make other settings, and perform calibration.

Before you start a channel parameter setting or calibration, you need to select this channel as active.

The measurements are executed for open channel windows in succession. Measurements for hidden channel windows are not executed.

#### 4.4.2 Number of Traces Setting

Each channel window can contain up to 8 different traces. Each trace is assigned the measured parameter  $S_{11}$  or  $S_{21}$ , display format and other parameters. The parameters related to a trace are listed in table 4.5.

The traces can be displayed in one graph, overlapping each other, or in separate graphs of a channel window. The trace settings are made in two steps: trace number setting and trace layout setting in the channel window. By default a channel window contains one trace. If you need to enable two or more traces, set the number of traces as described below.

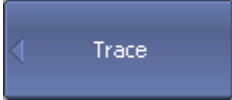
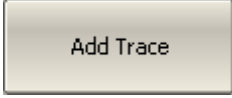
	To add a traces, use the following softkeys:
	<b>Trace &gt; Add Trace</b>
	Then select the number of traces from the menu.

All the traces are assigned their individual names, which cannot be changed. The trace name contains its number. The trace names are as follows: **Tr1, Tr2 ... Tr8**.

Each trace is assigned some initial settings: measured parameter, format, scale, and color, which can be modified by the user.

- By default the measured parameters are set in the following succession:  $S_{11}$ ,  $S_{21}$ . After that the measurements repeat in cycles.
- By default the display format for all the traces is set to logarithmic magnitude (dB).
- By default the scale is set to 100 dB, reference level value is set to 0 dB, reference level position is in the middle of the graph.
- The trace color is determined by its number.

Table 4.4 Channel parameters

N	Parameter Description
1	Sweep Type
2	Sweep Range
3	Number of Sweep Points
4	Stimulus Power Level
5	Power Slope Feature
6	CW Frequency
7	Segment Sweep Table
8	IF Bandwidth
10	Averaging
11	Calibration
12	Fixture Simulator

Table 4.5 Trace parameters

N	Parameter Description
1	Measured Parameter (S-parameter)
2	Display Format
3	Reference Level Scale, Value and Position
4	Electrical Delay, Phase Offset
5	Memory Trace, Math Operation
6	Smoothing
7	Markers
8	Time Domain
9	Parameter Transformation
10	Limit Test

### 4.4.3 Trace/Channel Activating

The control commands selected by the user are applied to the active channel or the active trace, respectively.

The border line of the active channel window is highlighted in light color. The active trace belongs to the active channel and its title is highlighted in inverse color.

Before you set a channel or trace parameters, first you need to activate the channel or trace, respectively.

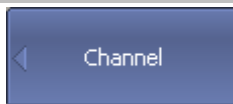

To activate a channel, use the following softkeys:

**Channel > Active Channel**

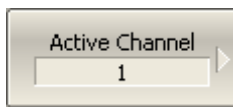

Then select the number of the active Channel.

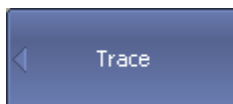

Then activate the trace by entering its number. To make it use the following softkeys:

**Trace > Active Trace**

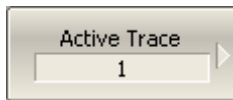

Then select the number of the active trace.

### 4.4.4 Active Channel Window Maximizing

When there are several channel windows displayed, you can temporarily maximize the active channel window to full screen size.

The other channel windows will be hidden, and this will interrupt the measurements in those channels.

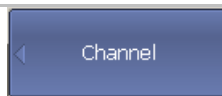

To enable/disable active channel maximizing function, use the following softkeys:

**Channel > Maximize Channel**

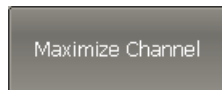

Note

Channel maximizing function can be controlled by a double mouse click on the channel.

## 4.5 Stimulus Setting

The stimulus parameters are set for each channel. Before you set the stimulus parameters of a channel, make this channel active.

---

Note	To make the measurement more accurate, perform measurements with the same stimulus settings as were used for the calibration.
------	-------------------------------------------------------------------------------------------------------------------------------

---

### 4.5.1 Sweep Type Setting



To set the sweep type, use the following softkeys:





**Stimulus > Sweep Type**

Then select the sweep type:

- **Lin Freq:** Linear frequency sweep
- **Log Freq:** Logarithmic frequency sweep
- **Segment:** Segment frequency sweep
- **Power Sweep:** Power sweep

### 4.5.2 Sweep Span Setting

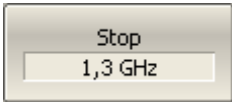
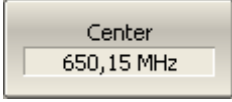
The sweep range should be set for linear and logarithmic frequency sweeps (Hz) and for linear power sweep (dBm). The sweep range can be set as Start / Stop or Center / Span values of the range.

	<p>To enter the start and stop values of the sweep range, use the following softkeys:</p>
	<p><b>Stimulus &gt; Start   Stop</b></p>
	
	<p>To enter center and span values of the sweep range, use the following softkeys:</p>
	<p><b>Stimulus &gt; Center   Span</b></p>
<p>Note</p>	<p>If the power sweep is activated, the values on the <b>Start</b>, <b>Stop</b>, <b>Center</b>, and <b>Span</b> softkeys will be represented in dBm.</p>

### 4.5.3 Sweep Points Setting

The number of sweep points should be set for linear and logarithmic frequency sweeps, and for linear power sweep.

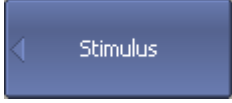
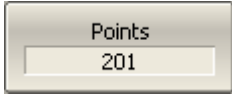
	<p>To enter the number of sweep points, use the following softkeys:</p>
	<p><b>Stimulus &gt; Points</b></p>

### 4.5.4 Stimulus Power Setting

The stimulus power level should be set for linear and logarithmic frequency sweeps. For the segment sweep type, the method of power level setting described in this section can be used only if the same power level is set for all the segments of the sweep. For setting of individual power level for each segment see section 4.5.8.



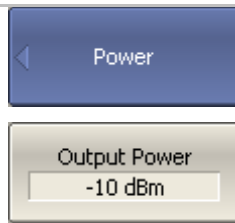

To enter the power level value, use the following softkeys:

**Stimulus > Power > Output Power**

#### 4.5.5 Power Slope Feature

The power slope feature allows for compensation of power attenuation with the frequency increase, in the fixture wire. The power slope can be set for linear, logarithmic and segment frequency sweeps.



To enter the power slope value, use the following softkeys:

**Stimulus > Power > Slope (dB/GHz)**

#### 4.5.6 CW Frequency Setting

CW frequency setting determines the source frequency for the linear power sweep.



To enter the CW frequency value, use the following softkeys:

**Stimulus > Power > CW Freq**

#### 4.5.7 RF Out Function

RF Out function allows temporary disabling of stimulus signal. While the stimulus is disabled the measurements cannot be performed.



To disable/enable stimulus, use the following softkeys:

**Stimulus > Power > RF Out**



Note

RF Out function is applied to the whole Analyzer, not to some channels. The indication about it will appear in the instrument status bar (See section 4.1.3).

## 4.5.8 Segment Table Editing

Segment table determines the sweep rule when segment sweep is activated.

---

To open the segment table, use the following softkeys:

**Stimulus > Segment Table**

---

When you switch to the **Segment Table** submenu, the segment table will open in the lower part of the screen. When you exit the **Segment Table** submenu, the segment table will become hidden.

The segment table layout is shown below. The table has three mandatory columns: frequency range and number of sweep points, and three columns, which you can enable/disable: IF bandwidth, power level and delay time.

	Start	Stop	Points	IFBW	Power
1	300 kHz	200 MHz	101	30 Hz	0 dBm
2	200 MHz	300 MHz	51	1 kHz	-10 dBm
3	300 MHz	500 MHz	101	10 kHz	-10 dBm
4	500 MHz	600 MHz	51	1 kHz	-10 dBm
5	600 MHz	1,3 GHz	401	30 Hz	0 dBm

Each row describes one segment. The table can contain one or more rows, up to 10001 (the total number of sweep points of all the segments).

---

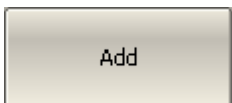
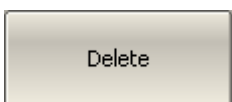
To add a segment to the table, click **Add** softkey. The new segment row will be entered below the highlighted one.

To delete a segment, click **Delete** softkey. The highlighted segment will be deleted.

---

For any segment it is necessary to set the mandatory parameters: frequency range and number of sweep points. The frequency range can be set either as **Start / Stop**, or as **Center / Span**.

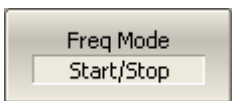

---

To set the frequency range representation mode, click **Freq Mode** softkey to select between **Start/Stop** and **Center/Span** options.

---

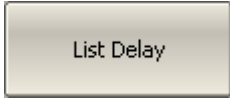

For any segment you can enable the additional parameter columns: IF bandwidth, power level, and delay time. If such a column is disabled, the corresponding value set for linear sweep will be used (same for all segments).

	<p>To enable the IF bandwidth column, click <b>List IFBW</b> softkey.</p>
	<p>To enable the power level column, click <b>List Power</b> softkey.</p>
	<p>To enable the delay time column, click <b>List Delay</b> softkey.</p>
	

To set a parameter, make a mouse click on its value field and enter the value. To navigate in the table you can use the keys of the keyboard (« ↑, « ↓, «←», «→»).

<p>Note</p>	<p>The adjacent segments do not overlap in the frequency domain.</p>
-------------	----------------------------------------------------------------------

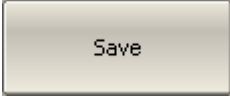
The segment table can be saved into \*.seg file to a hard disk and later recalled.

	<p>To save the segment table, click <b>Save</b> softkey. Then enter the file name in the appeared dialog.</p>
	
	<p>To recall the segment table, click <b>Recall</b> softkey. Then select the file name in the appeared dialog.</p>

### 4.5.9 Measurement Delay

Measurement delay function allows to add additional time interval at each measurement point between the moment when the source output frequency becomes stable and the moment of measurement start. This capability can be useful for measurements in narrowband circuits with transient period longer than the measurement in one point.

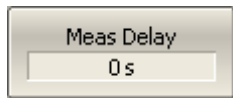
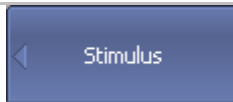

To set the time of measurement delay, use the following softkeys:

**Stimulus > Meas Delay**

Note

The maximum measurement delay is 0.3 sec.

---

## 4.6 Trigger Setting

The *trigger mode* determines the sweep actuation of all the channels. The channels can operate in one of the following three trigger modes:

- Continuous – a sweep actuation occurs every time a trigger signal is detected;
- Single – one sweep actuation occurs at one trigger signal detection after the mode has been enabled, after the sweep is complete the channel turns to hold mode;
- Hold – sweep actuation is off in the channel, the trigger signals do not affect the channel.

The trigger signal influences the whole Analyzer and controls the triggering of all the channels.

The *trigger source* is an internal trigger signal generated by the Analyzer on completion of the sweep over all the channels.



To set the trigger mode, use the following softkeys:

**Stimulus > Trigger**

Then select the required trigger mode:

- **Hold**
- **Single**
- **Continuous**

## 4.7 Measurement Parameters Setting

### 4.7.1 S-Parameters

For high-frequency network analysis the following terms are applied: incident, reflected and transmitted waves, transferred in the circuits of the setup (See figure 4.9).

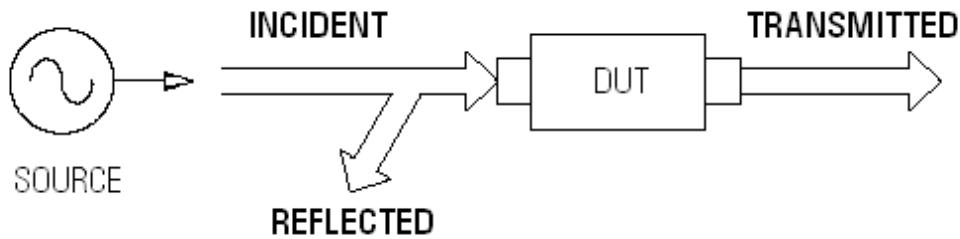

Figure 4.9

Measurement of magnitude and phase of incident, reflected and transmitted signals allow to determine the S-parameters (scattered parameters) of the DUT. An S-parameter is a relation between the complex magnitudes of the two waves:

$$S_{mn} = \frac{\text{transmitted wave at Port } m}{\text{incident wave at Port } n}$$

The Port 1 of the Analyzer operates as a signal source, and Port 2 operates as a signal receiver, that is why TR5048 allows measurement of  $S_{11}$  and  $S_{21}$  parameters simultaneously.

To measure  $S_{11}$  and  $S_{21}$  parameters, connect Port 1 to the input of the DUT, and Port 2 to the output of the DUT. The incident and reflected waves will be measured by Port 1. The transmitted wave will be measured by Port 2.

To measure  $S_{12}$  and  $S_{22}$  parameters, reconnect the DUT. Connect Port 1 to the output of the DUT, and Port 2 to the input of the DUT. The incident and reflected waves will be measured by Port 2. The transmitted wave will be measured by Port 1.

This way, using two connections of the DUT, you can measure full scattered matrix of a two-port DUT.

$$\mathbf{S} = \begin{bmatrix} S_{11} & S_{12} \\ S_{21} & S_{22} \end{bmatrix}$$

### 4.7.2 S-Parameter Setting

A measured parameter ( $S_{11}$  or  $S_{21}$ ) is set for each trace. Before you select the measured parameter, first activate the trace.

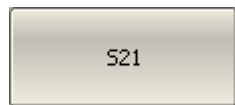
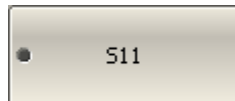
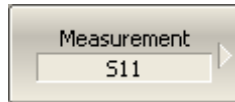
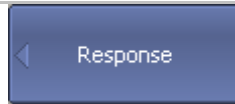

To set the measured parameter, use the following softkey:

**Response > Measurement**

Then select the required parameter by the corresponding softkey.

---

### 4.7.3 Absolute Measurements

The absolute measurement is the measurement of absolute power of a signal at a receiver input. Unlike relative measurements of S-parameters, which represent a relation between the signals at inputs of two receivers, absolute measurements determine the signal power at input of one receiver. Analyzer has three independent receivers: A, B, R.

R are the receiver of a reference signal, A and B are the receivers of a test signal. A and R receivers are located in port 1, B receiver are located in port 2.

### 4.7.4 Absolute Measurement Setting

Before you select the measured parameter, first activate the trace.

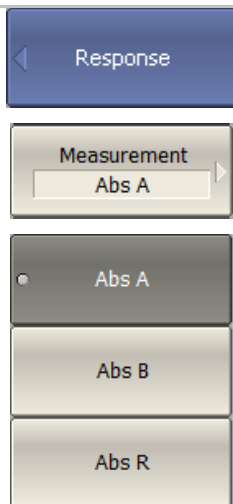

To set the measured parameter, use the following softkey:

**Response > Measurement**

Then select the required parameter by the corresponding softkey.

Note

In absolute measurement mode, dBm measurement units will be used for logarithmic magnitude format, W measurement units will be used for measurements in linear magnitude format. Other formats are not applied to absolute measurements as power is measured in scalar values.



## 4.8 Format Setting

The Analyzer offers the display of the measured S-parameters on the screen in three formats:

- rectangular format;
- polar format;
- Smith chart format.

### 4.8.1 Rectangular Formats

In this format, stimulus values are plotted along X-axis and the measured data are plotted along Y-axis (See figure 4.10).

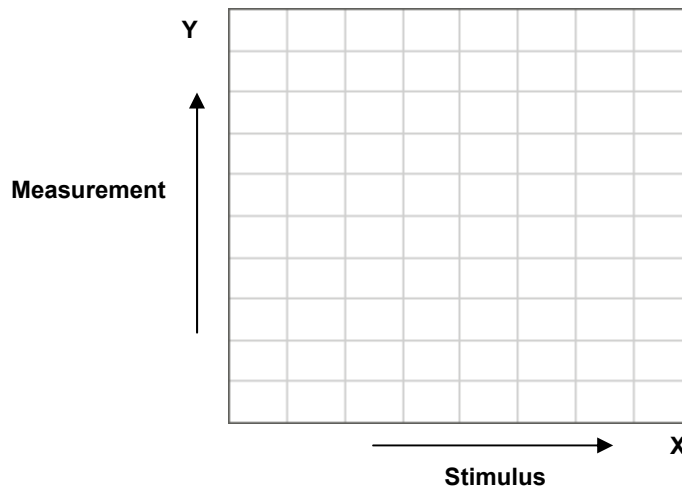

Figure 4.10 Rectangular format

To display S-parameter complex value along Y-axis, it should be transformed into a real number. Rectangular formats involve various types of transformation of an S-parameter  $S = a + j \cdot b$ , where:

- $a$  – real part of S-parameter complex value;
- $b$  – imaginary part of S-parameter complex value.

There are eight types of rectangular formats depending on the measured value plotted along Y-axis (See table 4.6).

Table 4.6 Rectangular formats

Format Type Description	Label	Data Type (Y-axis)	Measurement Unit (Y-axis)
Logarithmic Magnitude	Log Mag	S-parameter logarithmic magnitude: $20 \cdot \log S $ , $ S  = \sqrt{a^2 + b^2}$	Decibel (dB)
Voltage Standing Wave Ratio	SWR	$\frac{1 +  S }{1 -  S }$	Abstract number
Phase	Phase	S-parameter phase from $-180^\circ$ to $+180^\circ$ : $\frac{180}{\pi} \cdot \arctg \frac{a}{b}$	Degree (°)
Expanded Phase	Expand Phase	S-parameter phase, measurement range expanded to from below $-180^\circ$ to over $+180^\circ$	Degree (°)
Group Delay	Group Delay	Signal propagation delay within the DUT: $-\frac{d\varphi}{d\omega}$ , $\varphi = \arctg \frac{a}{b}$ , $\omega = 2\pi \cdot f$	Second (sec.)
Linear Magnitude	Lin Mag	S-parameter linear magnitude: $\sqrt{a^2 + b^2}$	Abstract number
Real Part	Real	S-parameter real part: $a = \text{re}(S)$	Abstract number
Imaginary Part	Imag	S-parameter imaginary part: $b = \text{im}(S)$	Abstract number

### 4.8.2 Polar Format

Polar format represents the measurement results on the pie chart (See figure 4.11). The distance to a measured point from the graph center corresponds to the magnitude of its value. The counterclockwise angle from the positive horizontal axis corresponds to the phase of the measured value.

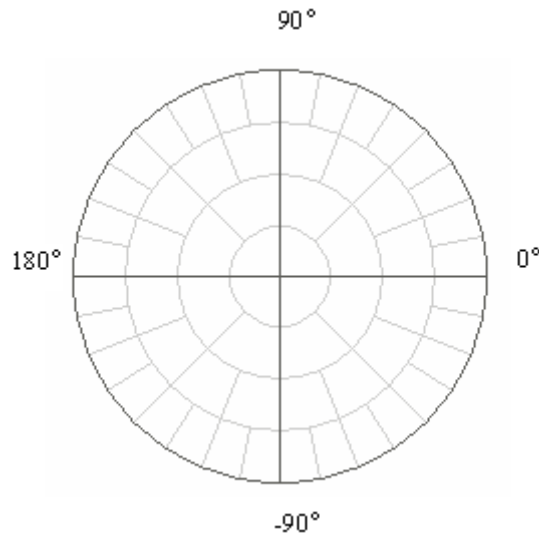

Figure 4.11 Polar format

The polar graph does not have a frequency axis, so frequency will be indicated by the markers. There are three types of polar formats depending on the data displayed by the marker. The traces will remain the same on all the graphs.

Table 4.7 Polar formats

Format Type Description	Label	Data Displayed by Marker	Measurement Unit (Y-axis)
Linear Magnitude and Phase	<b>Polar (Lin)</b>	S-parameter linear magnitude	Abstract number
		S-parameter phase	Degree
Logarithmic Magnitude and Phase	<b>Polar (Log)</b>	S-parameter logarithmic magnitude	Decibel (dB)
		S-parameter phase	Degree
Real and Imaginary Parts	<b>Polar (Re/Im)</b>	S-parameter real part	Abstract number
		S-parameter imaginary part	Abstract number

### 4.8.3 Smith Chart Format

Smith chart format is used for representation of impedance values for DUT reflection measurements. In this format, the trace has the same points as in polar format.

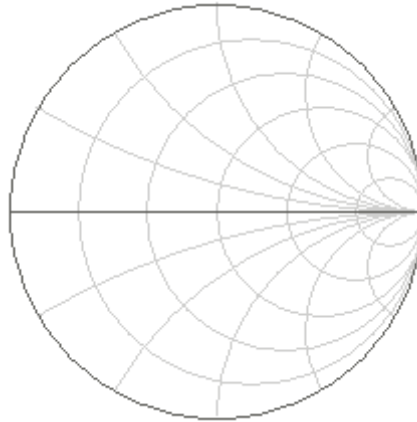

Figure 4.12 Smith chart format

The polar graph does not have a frequency axis, so frequency will be indicated by the markers. There are five types of Smith chart formats depending on the data displayed by the marker. The traces will remain the same on all the graphs.

Table 4.8 Smith chart formats

Format Type Description	Label	Data Displayed by Marker	Measurement Unit (Y-axis)
Linear Magnitude and Phase	Smith (Lin)	S-parameter linear magnitude	Abstract number
		S-parameter phase	Degree
Logarithmic Magnitude and Phase	Smith (Log)	S-parameter logarithmic magnitude	Decibel (dB)
		S-parameter phase	Degree
Real and Imaginary Parts	Smith (Re/Im)	S-parameter real part	Abstract number
		S-parameter imaginary part	Abstract number

Table 4.8 Smith chart formats (continued)

Complex Impedance (at Input)	Smith (R + jX)	Resistance at input: $R = re(Z_{inp})$ $Z_{inp} = Z_0 \frac{1+S}{1-S}$	Ohm ( $\Omega$ )
		Reactance at input: $X = im(Z_{inp})$	Ohm ( $\Omega$ )
		Equivalent capacitance or inductance: $C = -\frac{1}{\omega X}, X < 0$ $L = \frac{X}{\omega}, X > 0$	Farad (F) Henry (H)
Complex admittance (at Input)	Smith (G + jB)	Conductance at input: $G = re(Y_{inp})$ $Y_{inp} = \frac{1}{Z_0} \cdot \frac{1-S}{1+S}$	Siemens (S)
		Susceptance at input: $B = im(Y_{inp})$	Siemens (S)
		Equivalent capacitance or inductance: $C = \frac{B}{\omega}, B > 0$ $L = -\frac{1}{\omega B}, B < 0$	Farad (F) Henry (H)

$Z_0$  – test port impedance.  $Z_0$  setting is described in section 5.2.8.

#### 4.8.4 Data Format Setting

You can select the format for each trace of the channel individually. Before you set the format, first activate the trace.

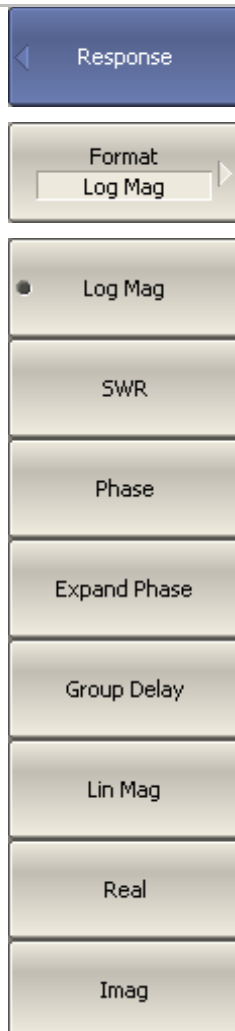

To set the rectangular format, use the following softkey:

**Response > Format**

Then select the required format:

- **Logarithmic magnitude**
- **SWR**
- **Phase**
- **Expanded phase**
- **Group delay**
- **Linear magnitude**
- **Real part**
- **Imaginary part**



To set the Smith chart format, use the following softkeys:

**Format > Smith**

Then select the required format:

- **Logarithmic magnitude and phase**
- **Linear magnitude and phase**
- **Real and imaginary parts**
- **Complex impedance (at input)**
- **Complex admittance (at input)**

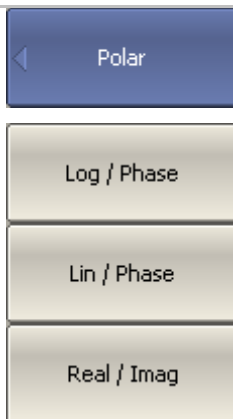

To set the polar format, use the following softkeys:

**Format > Polar**

Then select the required format:

- **Logarithmic magnitude and phase**
  - **Linear magnitude and phase**
  - **Real and imaginary parts**
-

## 4.9 Scale Setting

### 4.9.1 Rectangular Scale

For rectangular format you can set the following parameters (See figure 4.13):

- Trace scale;
- Reference level value;
- Reference level position;
- Number of scale divisions.

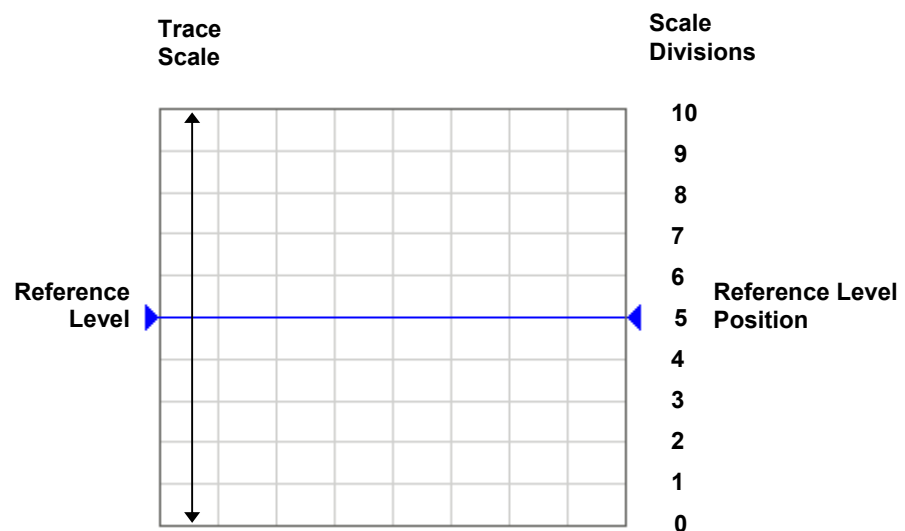
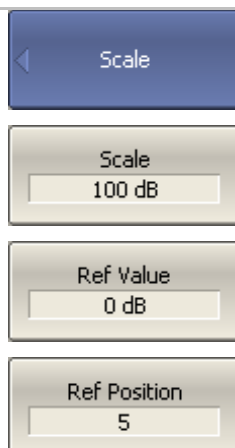

Figure 4.13 Rectangular scale

### 4.9.2 Rectangular Scale Setting

You can set the scale for each trace of a channel. Before you set the scale, first activate the trace.



To set the scale of a trace, use the following softkeys:

**Scale > Scale**

To set the reference level, use the following softkeys:

**Scale > Ref Value**

To set the position of the reference level, use the following softkeys:

**Scale > Ref Position**





To set the number of trace scale divisions, use the following softkeys:

**Scale > Divisions<sup>1</sup>**

Note

Quick trace scale setting by the mouse is described in section 4.3.

### 4.9.3 Circular Scale

For polar and Smith chart formats, you can set the outer circle value (See figure 4.14).

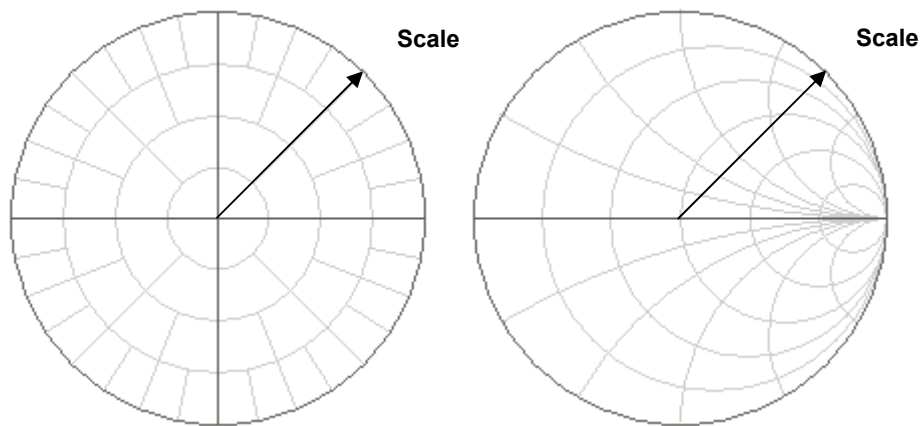
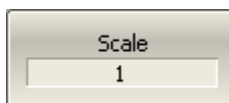

Figure 4.14 Circular scale

### 4.9.4 Circular Scale Setting



To set the scale of the circular graphs, use the following softkeys:



**Scale > Scale**

### 4.9.5 Automatic Scaling

The automatic scaling function automatically allows the user to define the trace scale so that the trace of the measured value could fit into the graph entirely.

In rectangular format, two parameters are adjustable: scale and reference level position. In circular format, the outer circle value will be adjusted.

<sup>1</sup> Number of the scale divisions affect all the graphs of the channel.

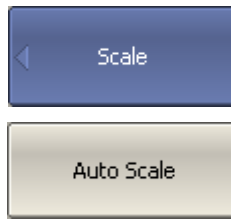

To execute the automatic scaling, use the following softkeys:

**Scale > Auto Scale**

#### 4.9.6 Reference Level Automatic Selection

This function executes automatic selection of the reference level in rectangular coordinates.

After the function has been executed, the trace of the measured value makes the vertical shift so that the reference level crosses the graph in the middle. The scale will remain the same.



To execute the automatic selection of the reference level, use the following softkeys:

**Scale > Auto Ref Value**

#### 4.9.7 Electrical Delay Setting

The electrical delay function allows the user to define the compensation value for the electrical delay of a device. This value is used as compensation for the electrical delay during non-linear phase measurements. The electrical delay is set in seconds.

If the electrical delay setting is other than zero, S-parameter value will vary in accordance with the following formula:

$$S = S \cdot e^{j \cdot 2\pi \cdot f \cdot t}, \quad \text{where}$$

$f$  – frequency, Hz,

$t$  – electrical delay, sec.

The electrical delay is set for each trace individually. Before you set the electrical delay, first activate the trace.

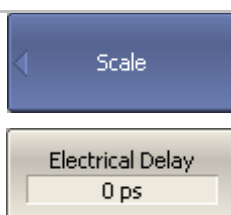

To set the electrical delay, use the following softkeys:

**Scale > Electrical Delay**

### 4.9.8 Phase Offset Setting

The phase offset function allows the user to define the constant phase offset of a trace. The value of the phase offset is set in degrees for each trace individually. Before you set the phase offset, first activate the trace.



To set the phase offset, use the following softkeys:

**Scale > Phase Offset**

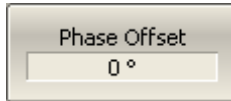

## 4.10 Measurement Optimizing

You can set IF bandwidth, averaging and smoothing parameters in **Response** softkey submenu.

### 4.10.1 IF Bandwidth Setting

The IF bandwidth function allows the user to define the bandwidth of the test receiver. The IF bandwidth can take on the following values: 10 Hz, 30 Hz, 100 Hz, 300 Hz, 1 kHz, 3 kHz, 10 kHz, 30 kHz.

The IF bandwidth narrowing allows to reduce self-noise and widen the dynamic range of the Analyzer. Also the sweep time will increase. Narrowing of the IF bandwidth by 10 will reduce the receiver noise by 10 dB.

The IF bandwidth should be set for each channel individually. Before you set the IF bandwidth, first activate the channel.

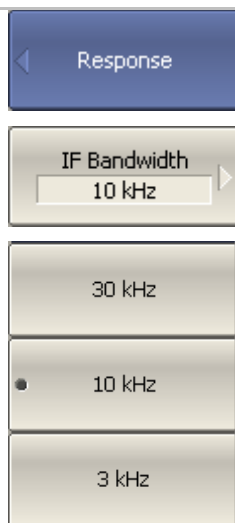

To set the IF bandwidth, use the following softkeys:

**Response > IF Bandwidth**

Then select the required value from the list.

### 4.10.2 Averaging Setting

The averaging in a measurement point is made over several previous sweeps. The averaging function is similar to IF bandwidth narrowing. It allows you to reduce self-noise and widen the dynamic measurement range of the Analyzer.

The averaging in each measurement point is made over several sweeps in accordance with the following equation:

$$\begin{cases} M_i = S_i, & i = 0 \\ M_i = \left(1 - \frac{1}{n}\right) \cdot M_{i-1} + \frac{S_i}{n}, & i > 0, \quad n = \min(i + 1, N) \end{cases}$$

$M_i$  - i-sweep averaging result;

$S_i$  - i-sweep measurement parameter (S-parameter) value;

$N$  - averaging factor is set by the user from 1 to 999; the higher the factor value the stronger the averaging effect.

When the averaging function is enabled, the current number of iterations and the averaging factor, e.g. «9/10», will appear in the channel status bar. The averaging process is considered stable when the both numbers have become equal.

The averaging should be set for each channel individually. Before you set the averaging, first activate the channel.

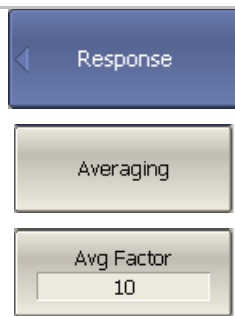

To toggle the averaging function on/off, use the following softkeys:

**Response > Averaging**

To set the averaging factor, use the following softkeys

**Response > Avg Factor**

#### 4.10.3 Smoothing Setting

The smoothing of the sweep results is made by averaging of adjacent points of the trace determined by the moving aperture. The aperture is set by the user in percent against the total number of the trace points.

The smoothing does not increase dynamic range of the Analyzer. It does not affect the average level of the trace, but it reduces the noise bursts.

The smoothing should be set for each trace individually. Before you set the smoothing, first activate the trace.

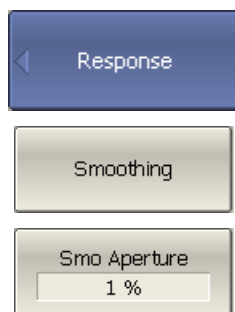

To toggle the smoothing function on/off, use the following softkeys:

**Response > Smoothing**

To set the smoothing aperture, use the following softkeys:

**Response > Smo Aperture**

#### 4.10.4 Max Hold function

The Max Hold function displays the maximum of any given active measurement instead the real-time data. The held data is displayed as a active trace.

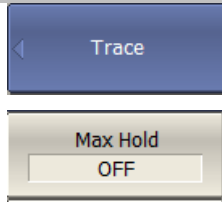

To toggle the Max Hold function on/off, use the following softkeys:

**Trace > Max Hold**

---

## 5 CALIBRATION AND CALIBRATION KIT

### 5.1 General Information

#### 5.1.1 Measurement Errors

S-parameter measurements are influenced by various measurement errors, which can be broken down into two categories:

- systematic errors, and
- random errors.

Random errors comprise such errors as noise fluctuations and thermal drift in electronic components, changes in the mechanical dimensions of cables and connectors subject to temperature drift, repeatability of connections and cable bends. Random errors are unpredictable and hence cannot be estimated and eliminated in calibration. Random errors can be reduced by correct setting of the source power, IF bandwidth narrowing, maintaining constant environment temperature, observance of the Analyzer warm-up time, careful connector handling, avoidance of cable bending after calibration, and use of the calibrated torque wrench for connection of the Male-Female coaxial RF connectors.

Random errors and related methods of correction are not mentioned further in this section.

Systematic errors are the errors caused by imperfections in the components of the measurement system. Such errors occur repeatedly and their characteristics do not change with time. Systematic errors can be determined and then reduced by performing mathematical correction of the measurement results.

The process of measurement of precision devices with predefined parameters with the purpose of determination of measurement systematic errors is called **calibration**, and such precision devices are called **calibration standards**. The most commonly used calibration standards are SHORT, OPEN, and LOAD.

The process of mathematical compensation (numerical reduction) for measurement systematic errors is called an **error correction**.

### 5.1.2 Systematic Errors

The systematic measurement errors of vector network analyzers are subdivided into the following categories according to their source:

- Directivity;
- Source match;
- Load match;
- Isolation;
- Reflection/transmission tracking.

The measurement results before the procedure of error correction has been executed are called **uncorrected**.

The residual values of the measurement results after the procedure of error correction are called **effective**.

#### ▪ Directivity Error

A directivity error (**Ed**) is caused by incomplete separation of the incident signal from the reflected signal by the directional coupler in the source port 1. In this case part of the incident signal energy comes to the receiver of the reflected signal. Directivity errors do not depend on the characteristics of the DUT and usually have stronger effect in reflection measurements.

#### ▪ Source Match Error

A source match error (**Es**) is caused by the mismatch between the source port 1 and the input of the DUT. In this case part of the signal reflected by the DUT reflects at the port 1 and again comes into the input of the DUT. The error occurs both in reflection measurement and in transmission measurement. Source match errors depend on the relation between input impedance of the DUT and test port 1 impedance.

Source match errors have strong effect in measurements of a DUT with poor input matching.

#### ▪ Load Match Error

A load match error (**EI**) is caused by the mismatch between the receiver port 2 and the output of the DUT. In this case part of the signal transmitted through the DUT reflects at the port 2 and comes to the output of the DUT. The error occurs in transmission measurements and in reflection measurements (for a 2-port DUT). Load match errors depend on the relation between output impedance of the DUT and test port 2 impedance.



In transmission measurements the load match error has considerable influence if the output of the DUT is poorly matched.

In reflection measurements the load match error has considerable influence in case of poor match of the output of the DUT and low attenuation between the output and input of the DUT.

- Isolation Error

An isolation error (**Ex**) is caused by a leakage of the signal from the source port to the receiver port escaping transmission through the DUT.

- Reflection Tracking Error

A reflection tracking error (**Er**) is caused by the difference in frequency response between the test receiver and the reference receiver of the port 1 in reflection measurement.

- Transmission Tracking Error

A transmission tracking error (**Et**) is caused by the difference in frequency response between the test receiver of the receiver port and the reference receiver of the source port in transmission measurement.

### 5.1.3 Error Modeling

Error modeling and method of signal flow graphs are applied to vector network analyzers for analysis of its systematic errors.

#### 5.1.3.1 One-Port Error Model

In reflection measurement only port 1 of the Analyzer is used. The signal flow graph of errors for the port 1 is represented in figure 5.1.

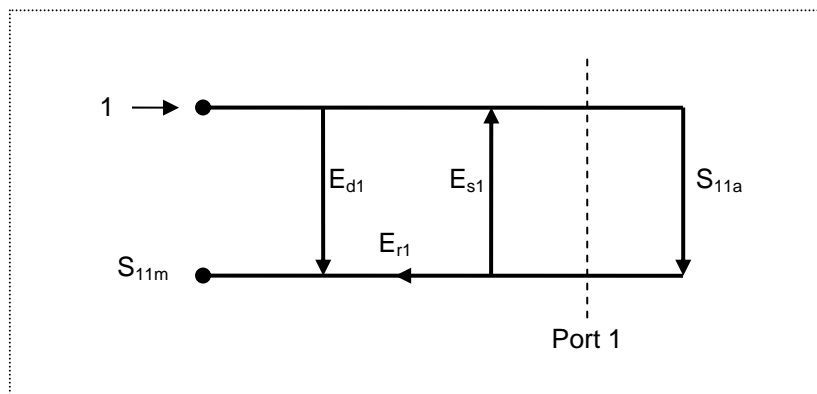

Figure 5.1 One-port error model

Where:

- $S_{11a}$  – reflection coefficient true value;
- $S_{11m}$  – reflection coefficient measured value.

The measurement result at port 1 is affected by the following three systematic error terms:

- $E_{d1}$  – directivity;
- $E_{s1}$  – source match;
- $E_{r1}$  – reflection tracking.

For normalization the stimulus value is taken equal to 1. All the values used in the model are complex.

After determining all the three error terms  $E_{d1}$ ,  $E_{s1}$ ,  $E_{r1}$  for each measurement frequency by means of a **full 1-port calibration**, it is possible to calculate (mathematically subtract the errors from the measured value  $S_{11m}$ ) the true value of the reflection coefficient  $S_{11a}$ .

There are simplified methods, which eliminate the effect of only one out of the three systematic errors.

### 5.1.3.2 One-Path Two-Port Error Model

For a one-path measurement of the reflection coefficient and the transmission coefficient of a two-port DUT, the two ports of the Analyzer are used.

The signal flow graph of errors effect in a one-path two-port system is represented in figure 5.2:

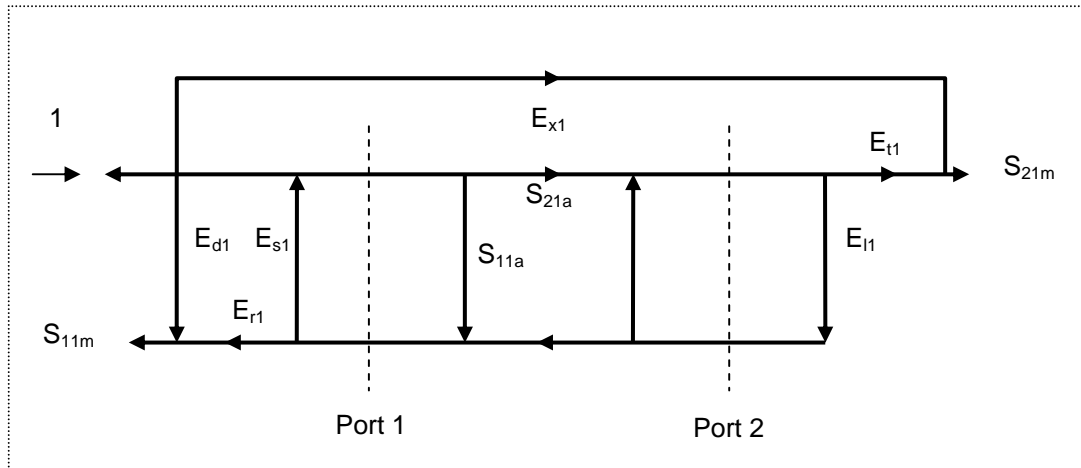

Figure 5.2 One-path two-port error model

Where:

- $S_{11a}, S_{21a}$  – true values of the DUT parameters;
- $S_{11m}, S_{21m}$  – measured values of the DUT parameters.

For normalization the stimulus value is taken equal to 1. All the values used in the model are complex.

The measurement result in a one-path two-port system is affected by six systematic error terms.

Table 5.1 Systematic error terms

Description	Error
Directivity	$E_{d1}$
Source match	$E_{s1}$
Reflection tracking	$E_{r1}$
Transmission tracking	$E_{t1}$
Load match	$E_{l1}$
Isolation	$E_{x1}$

After determination of the four error terms ( $E_{d1}$ ,  $E_{s1}$ ,  $E_{r1}$ ,  $E_{t1}$ ) for each measurement frequency by means of a **one-path two-port calibration**, it is possible to calculate the true value of the  $S_{11m}$ . The calibration does not take error terms  $E_{l1}$  and  $E_{x1}$  into account, that is why the measured value of  $S_{21m}$  will be coming closer to the true value of  $S_{21a}$  with improvement of the source match and increasing of the isolation.

#### 5.1.4 Analyzer Test Ports Defining

The test ports of the Analyzer are defined by means of calibration. The test port is a connector accepting a calibration standard in the process of calibration.

A type-N 50  $\Omega$  Female connector on the front panel of the Analyzer will be the test port if the calibration standards are connected directly to it.

Sometimes it is necessary to connect coaxial cable and/or adapter to the connector on the front panel for connection of the DUT with a different connector type. In such cases connect calibration standards to the connector of the cable or adapter.

Figure 5.3 represents two cases of test port defining for the measurement of the DUT. The use of cables and/or adapters does not affect the measurement results if they were integrated into the process of calibration.

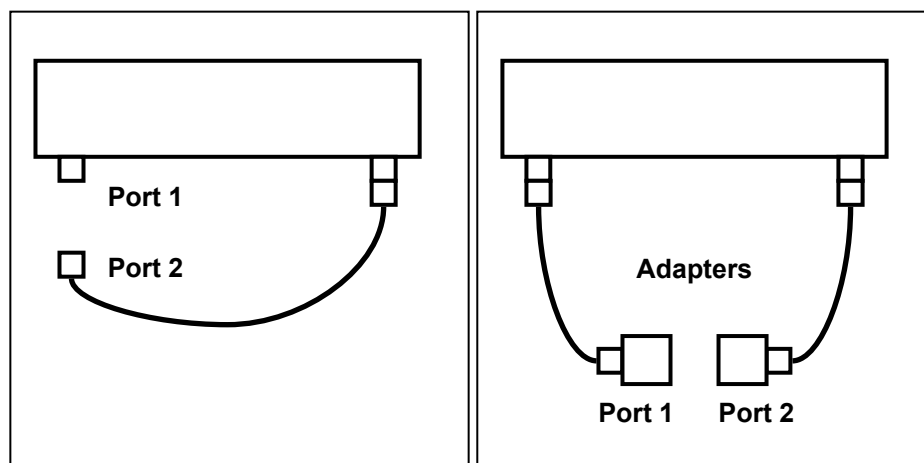

Figure 5.3 Test port defining

In some cases, the term of *calibration plane* is used. Calibration plane is an imaginary plane located at the ends of the connectors, which accept calibration standards during calibration.

### 5.1.5 Calibration Steps

The process of calibration comprises the following steps:

- Selection of the calibration kit matching the connector type of the test port. The calibration kit includes such standards as SHORT, OPEN, and LOAD with matched impedance. Magnitude and phase responses i.e. S-parameters of the standards are well known. The characteristics of the standards are represented in the form of an **equivalent circuit model**, as described below;
- Selection of a calibration method (see section 5.1.6) is based on the required accuracy of measurements. The calibration method determines what error terms of the model (or all of them) will be compensated;
- Measurement of the standards within a specified frequency range. The number of the measurements depends on the type of calibration;
- The Analyzer compares the measured parameters of the standards against their predefined values. The difference is used for calculation of the calibration coefficients (systematic errors);
- The table of calibration coefficients is saved into the memory of the Analyzer and used for error correction of the measured results of any DUT.

Calibration is applied to the Analyzer as a whole and affects all the channels. This means that one table of calibration coefficients is being stored for all the channels.

### 5.1.6 Calibration Methods

The Analyzer supports several methods of one-port and two-port calibrations. The calibration methods vary by quantity and type of the standards being used, by type of error correction. The table 5.2 represents the overview of the calibration methods.

Table 5.2 Calibration methods

Calibration Method	Parameters	Standards	Errors
Reflection Normalization	$S_{11}$	SHORT or OPEN	$E_{r1}, E_{d1}$
Transmission Normalization	$S_{21}$	THRU	$E_{t1}, E_{x1}$
Full One-Port Calibration	$S_{11}$	SHORT OPEN LOAD	$E_{r1}, E_{d1}, E_{s1}$
One-Path Two-Port Calibration	$S_{11}, S_{21}$	SHORT OPEN LOAD THRU	$E_{r1}, E_{d1}, E_{s1}, E_{t1}, E_{x1}$

#### 5.1.6.1 Normalization

Normalization is the simplest method of calibration as it involves measurement of only one calibration standard for each S-parameter.

- 1-port (reflection) S-parameter ( $S_{11}$ ) is calibrated by means of a SHORT or an OPEN standard, estimating reflection tracking error term **Er**.
- 2-port (transmission) S-parameter ( $S_{21}$ ) is calibrated by means of a THRU standard, estimating transmission tracking error term **Et**.

This method is called normalization because the measured S-parameter at each frequency point is divided (normalized) by the corresponding S-parameter of the calibration standard.

Normalization eliminates frequency-dependent attenuation and phase offset in the measurement circuit, but does not compensate for errors of directivity and mismatch.

### 5.1.6.2 Full One-Port Calibration

Full one-port calibration involves connection of the following three standards to test port 1:

- SHORT,
- OPEN,
- LOAD.

Measurement of the three standards allows for acquisition of all the three error terms (**Ed, Es, and Er**) of a one-port model. Full 1-port calibration is used for reflection measurement ( $S_{11}$ ) of the DUT.

### 5.1.6.3 One-Path Two-Port Calibration

A one-path two-port calibration combines full one-port calibration with transmission normalization. This method allows for a more accurate estimation of transmission tracking error (**Et**) than using transmission normalization.

One-path two-port calibration involves connection of the three standards to the port 1 of the Analyzer (as for one-port calibration) and a THRU standard connection between port 1 and port 2.

One-path two-port calibration allows for correction of **Ed, Es, and Er** error terms of the port 1 and a transmission tracking error term (**Et**). This method does not derive source match error term (**EI**) and isolation  $E_{x1}$  of a one-path 2-port error model.

One-path two-port calibration is used for measurements of the parameters of a DUT in one direction  $S_{11}$  and  $S_{21}$ .

### 5.1.7 Calibration Standards and Calibration Kits

Calibration standards are precision physical devices used for determination of errors in a measurement system.

A calibration kit is a set of calibration standards for a specific type of connector and specific impedance. Calibration kit includes standards of the four following types: SHORT, OPEN, LOAD and THRU.

The characteristics of real calibration standards have deviations from the ideal values. For example, the ideal SHORT standard must have reflection coefficient magnitude equal to 1.0 and reflection coefficient phase equal to  $180^\circ$  over the whole frequency range. A real SHORT standard has deviations from these values depending on the frequency. To take into account such deviations a **calibration standard model** (in the form of an equivalent circuit with predefined characteristics) is used.

The Analyzer provides definitions of calibration kits produced by different manufacturers. The user can add the definitions of own calibration kits or modify the predefined kits. Calibration kits editing procedure is described in the section 5.3.

To ensure the required calibration accuracy, select the calibration kit being used in the program menu. The procedure of calibration kit selection is described in section 5.2.1.

- **Types of Calibration Standards**

Calibration standard type is a category of physical devices used to define the parameters of the standard. The Analyzer supports the following types of the calibration standards:

- OPEN,
- SHORT,
- LOAD,
- THRU.



- Calibration Standard Model

A model of a calibration standard presented as an equivalent circuit is used for determining of S-parameters of the standard. The model is employed for standards of OPEN, SHORT, LOAD types.

One-port model is used for the standards OPEN, SHORT, and LOAD (See figure 5.4).

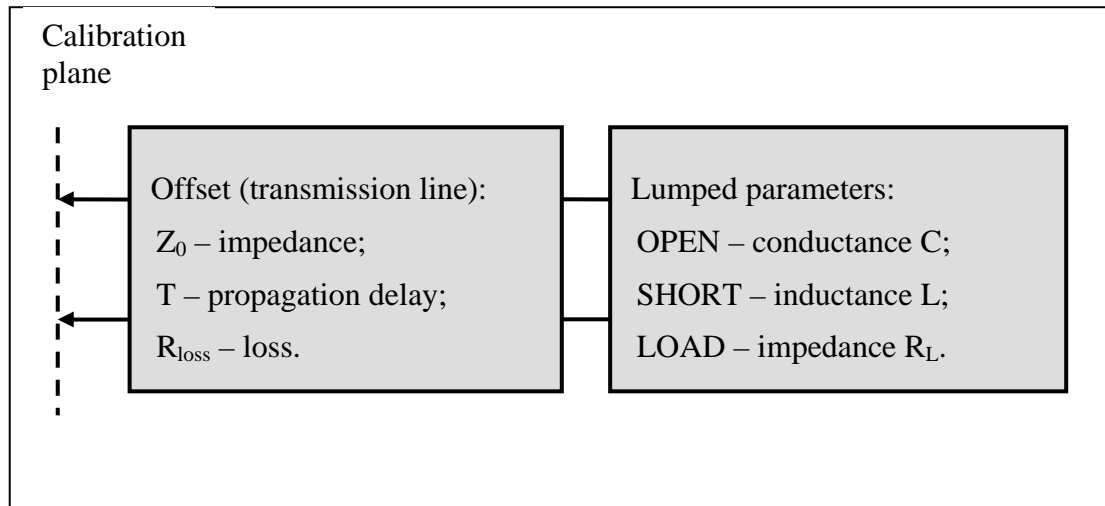

Figure 5.4 One-port standard model

The description of the numeric parameters of an equivalent circuit model of a calibration standard is shown in table 5.3.

Table 5.3 Parameters of the calibration standard equivalent circuit model

Parameter (as in the program)	Parameter Definition
<b>Z<sub>o</sub></b> (Offset Zo)	It is the offset impedance (of a transmission line) between the calibration plane and the circuit with lumped parameters.
<b>T</b> (Offset Delay)	The offset delay. It is defined as one-way propagation time (in seconds) from the calibration plane to the circuit with lumped parameters or to the other calibration plane. Each standard delay can be measured or mathematically determined by dividing the exact physical length by the propagation velocity.
<b>R<sub>loss</sub></b> (Offset Loss)	<p>The offset loss in one-way propagation due to the skin effect. The loss is defined in Ω/sec at 1 GHz frequency. The loss in a transmission line is determined by measuring the delay T [sec] and loss L [dB] at 1 GHz frequency. The measured values are used in the following formula:</p> $Rn[\Omega/s] = \frac{L[dB] \cdot Z_0[\Omega]}{4.3429[dB] \cdot T[s]}$
<b>C</b> (C <sub>0</sub> , C <sub>1</sub> , C <sub>2</sub> , C <sub>3</sub> )	<p>The fringe capacitance of an OPEN standard, which causes a phase offset of the reflection coefficient at high frequencies. The fringe capacitance model is described as a function of frequency, which is a polynomial of the third degree:</p> $C = C_0 + C_1 f + C_2 f^2 + C_3 f^3$ <p>where f – frequency [Hz] C<sub>0</sub>...C<sub>3</sub> – polynomial coefficients Units: C<sub>0</sub>[F], C<sub>1</sub>[F/Hz], C<sub>2</sub>[F/Hz<sup>2</sup>], C<sub>3</sub>[F/Hz<sup>3</sup>]</p>
<b>L</b> (L <sub>0</sub> , L <sub>1</sub> , L <sub>2</sub> , L <sub>3</sub> )	<p>The residual inductance of a SHORT standard, which causes a phase offset of the reflection coefficient at high frequencies. The residual inductance model is described as a function of frequency, which is a polynomial of the third degree:</p> $L = L_0 + L_1 f + L_2 f^2 + L_3 f^3$ <p>where f – frequency [Hz] L<sub>0</sub>...L<sub>3</sub> – polynomial coefficients Units: L<sub>0</sub>[H], L<sub>1</sub>[H/Hz], L<sub>2</sub>[H/Hz<sup>2</sup>], L<sub>3</sub>[H/Hz<sup>3</sup>]</p>

## 5.2 Calibration Procedures

### 5.2.1 Calibration Kit Selection

The Analyzer provides memory space for eleven calibration kits. The first two items are the calibration kits with indefinite parameters. Next six items are the kits with manufacturer-defined parameters, available in the Analyzer by default. The other three items are the empty templates offered for calibration kit definition by the user.

The available calibration kits include the kits of Rosenberger and Agilent (See table 5.4).

Table 5.4 Calibration kits

No.	Model Number	Calibration Kit Description
1	Not Def 50 Ohm	50 Ω, parameters not defined
2	Not Def 75 Ohm	75 Ω, parameters not defined
3	05CK10A-150 -F-	Rosenberger 05CK10A-150 -F- 50 Ω N-type Female, up to 18 GHz
4	05CK10A-150 -M-	Rosenberger 05CK10A-150 -M- 50 Ω N-type Male, up to 18 GHz
5	Agil. 85032B -F-	Agilent 85032B or 85032E, 50 Ω N-type Female, up to 6 GHz
6	Agil. 85032B -M-	Agilent 85032B or 85032E, 50 Ω N-type Male, up to 6 GHz
7	Agil. 85036B -F-	Agilent 85036B or 85036E, N-type (75 Ω) Female, up to 3 GHz
8	Agil. 85036B -M-	Agilent 85036B or 85036E, N-type (75 Ω) Male, up to 3 GHz
9 – 16	Empty	Templates for user-defined calibration kits

---

Note	-M- or -F- in the description of the kit denotes the polarity of the calibration standard connector, male or female respectively.
------	-----------------------------------------------------------------------------------------------------------------------------------

---

To achieve the specified measurement accuracy, use a calibration kit with known characteristics.

Before starting calibration select in the program the calibration kit being used among the predefined kits, or define a new one and enter its parameters.

Make sure that parameters of your calibration standards correspond to the values stored in the memory of the Analyzer. If they do not, make the required changes.

The procedure of a calibration kit definition and editing is described in section 5.3.

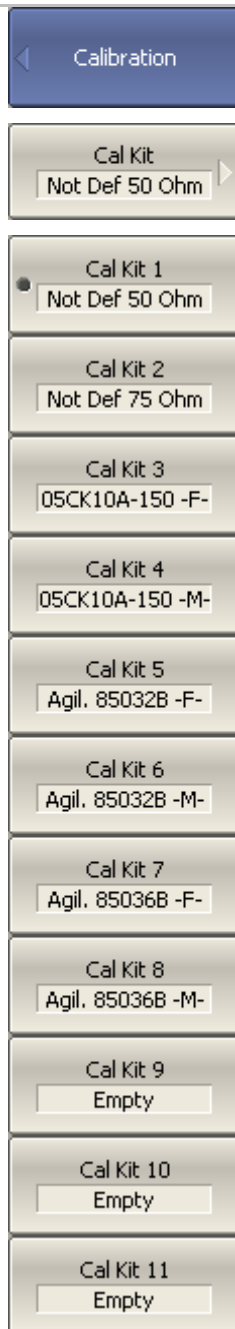

To select the calibration kit, use the following softkeys:

**Calibration > Cal Kit**

Then select the required kit from the softkey menu.

The currently selected calibration kit is indicated on the **Cal Kit** softkey and on the top softkey of each calibration method menu.

## 5.2.2 Reflection Normalization

Reflection normalization is the simplest calibration method used for reflection coefficient measurement ( $S_{11}$ ). Only one standard (SHORT or OPEN) is measured (See figure 5.5) in the process of this calibration

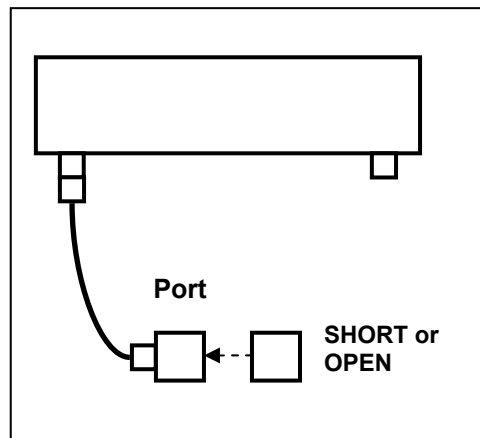
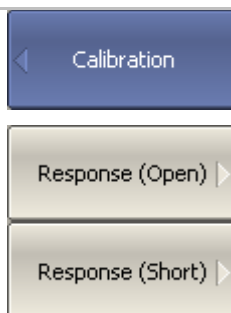

Figure 5.5 Reflection normalization

Before starting calibration perform the following settings: select active channel, set the parameters of the channel (frequency range, IF bandwidth, etc), and select the calibration kit.



To perform reflection normalization, use the following softkeys:

**Calibration > Calibrate > Response (Open) | Response (Short)**



Connect an OPEN or a SHORT standard to the port 1 as shown in figure 5.5. Perform measurement using **Open** or **Short** softkey respectively.

During the measurement, a pop up window will appear in the channel window. It will have **Calibration** label and will indicate the progress of the measurement. On completion of the measurement, a checkmark will appear in the left part of the softkey.

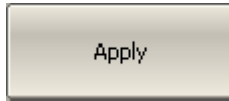

To complete the calibration procedure, click **Apply**.

This will activate the process of calibration coefficient table calculation and saving it into the memory. The error correction function will also be automatically enabled.

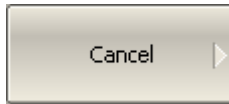

To clear the measurement results of the standards, click **Cancel**.

This softkey does not cancel the current calibration. To disable the current calibration turn off the error correction function (See section 5.2.6).

---

Note

You can check the calibration status in the trace status field (See table 5.5).

---

### 5.2.3 Transmission Normalization

Transmission normalization is the simplest calibration method used for transmission coefficient measurement ( $S_{21}$ ). One THRU standard is measured (See figure 5.6) in the process of this calibration.

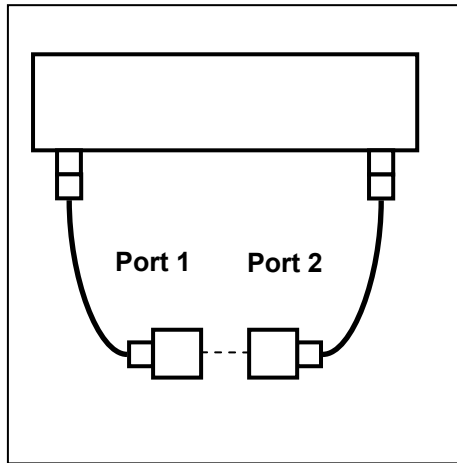

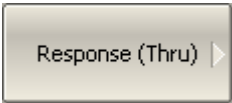

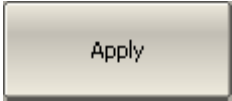

Figure 5.6 Transmission normalization

Before starting calibration perform the following settings: select active channel, set the parameters of the channel (frequency range, IF bandwidth, etc), and select the calibration kit.

 	<p>To perform transmission normalization, use the following softkeys:</p> <p><b>Calibration &gt; Calibrate &gt; Response (Thru)</b></p>
	<p>Connect a THRU standard between the test ports. If the port connectors allow through connection connect them directly. Perform measurement using <b>Thru</b> softkey.</p> <p>During the measurement, a pop up window will appear in the channel window. It will have <b>Calibration</b> label and will indicate the progress of the measurement. On completion of the measurement, a checkmark will appear in the left part of the softkey.</p>
	<p>To complete the calibration procedure, click <b>Apply</b>.</p> <p>This will activate the process of calibration coefficient table calculation and saving it into the memory. The error correction function will also be automatically enabled.</p>



To clear the measurement results of the standards, click **Cancel**.

This softkey does not cancel the current calibration. To disable the current calibration turn off the error correction function (See section 5.2.6).

---

Note

You can check the calibration status in the trace status field (See table 5.5).

---



### 5.2.4 Full One-Port Calibration

Full one-port calibration is used for reflection coefficient measurement ( $S_{11}$ ). The three calibration standards (SHORT, OPEN, LOAD) are measured (See figure 5.7) in the process of this calibration.

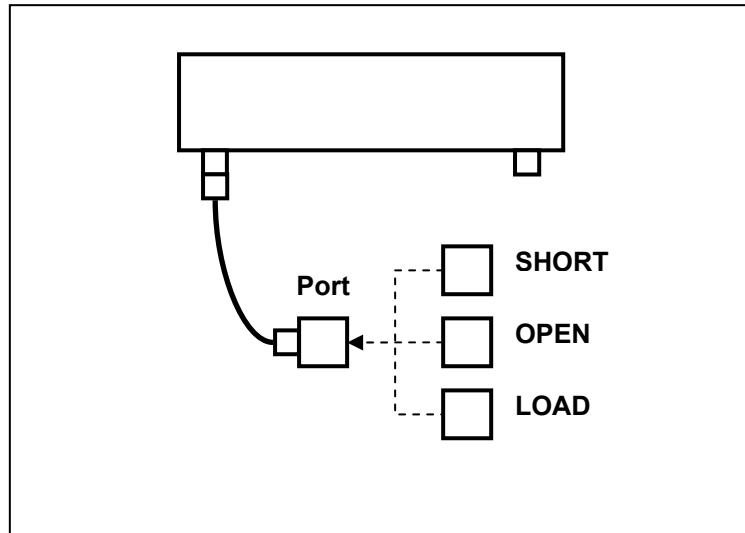



Figure 5.7 Full one-port calibration

Before starting calibration perform the following settings: select active channel, set the parameters of the channel (frequency range, IF bandwidth, etc), and select the calibration kit.

	<p>To perform full one-port calibration, use the following softkeys:</p>
	<p><b>Calibration &gt; Calibrate &gt; Full 1-Port Calibration</b></p>
	<p>Connect SHORT, OPEN and LOAD standards to the test port in any consequence as shown in figure 5.7. Perform measurements clicking the softkey corresponding to the connected standard, SHORT, OPEN or LOAD respectively.</p>
<p>During the measurement, a pop up window will appear in the channel window. It will have <b>Calibration</b> label and will indicate the progress of the measurement. On completion of the measurement, a checkmark will appear in the left part of the softkey.</p>	

	<p>To complete the calibration procedure, click <b>Apply</b>.</p> <p>This will activate the process of calibration coefficient table calculation and saving it into the memory. The error correction function will also be automatically enabled.</p>
	<p>To clear the measurement results of the standards, click <b>Cancel</b>.</p> <p>This softkey does not cancel the current calibration. To disable the current calibration turn off the error correction function (See section 5.2.6).</p>
Note	<p>You can check the calibration status in the trace status field (See table 5.5).</p>

### 5.2.5 One-Path Two-Port Calibration

One-path two-port calibration is used for measurements of the DUT parameters in one direction, e.g.  $S_{11}$  and  $S_{21}$ . This method involves connection of the three calibration standards to port 1, and connection of a THRU standard between port 1 and port 2 (See figure 5.8).

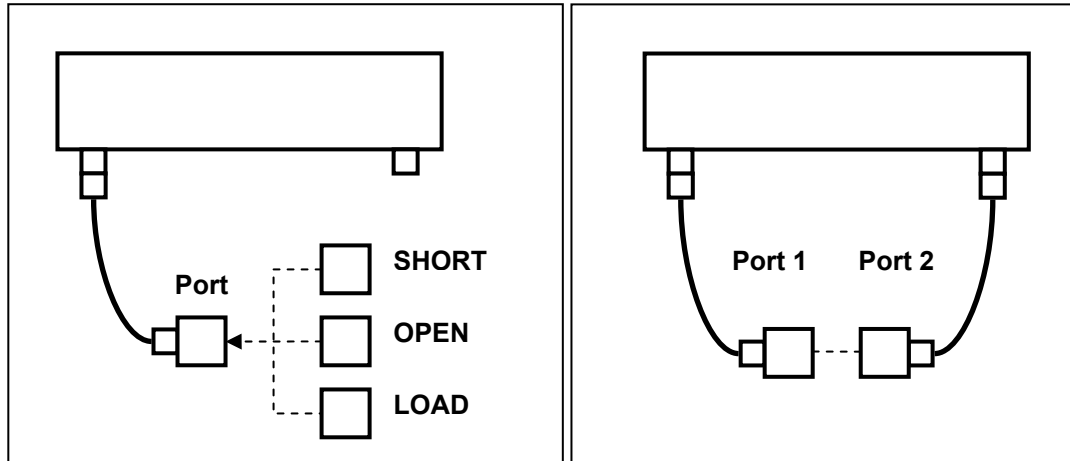
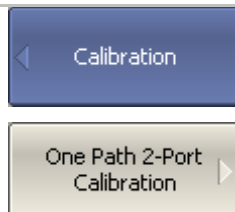

Figure 5.8 One-path two-port calibration

Before starting calibration perform the following settings: select active channel, set the parameters of the channel (frequency range, IF bandwidth, etc), and select the calibration kit.



To perform one-path two-port calibration, use the following softkeys:

**Calibration > Calibrate > One Path 2-Port Calibration**

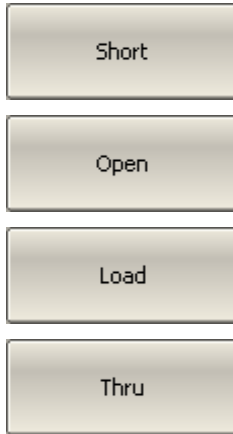

Connect SHORT, OPEN and LOAD standards to port 1 in any consequence, as shown in figure 5.8. Perform measurements clicking the softkey corresponding to the connected standard, SHORT, OPEN or LOAD respectively.

Connect a THRU standard between the test ports. If the port connectors allow through connection connect them directly. Perform measurement using Thru softkey.

During the measurement, a pop up window will appear in the channel window. It will have Calibration label and will indicate the progress of the measurement. On completion of the measurement, a checkmark will appear in the left part of the softkey.

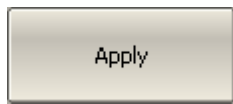

To complete the calibration procedure, click Apply.

This will activate the process of calibration coefficient table calculation and saving it into the memory. The error correction function will also be automatically enabled.

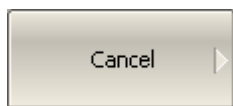

To clear the measurement results of the standards, click Cancel.

This softkey does not cancel the current calibration. To disable the current calibration turn off the error correction function (See section 5.2.6).

#### Note

You can check the calibration status in the trace status field (See table 5.5).

## 5.2.6 Error Correction Disabling

This feature allows the user to disable the error correction function, which automatically becomes enabled after completion of calibration by any method.

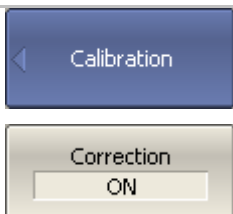

To disable and enable again the error correction function, use the following softkeys:

**Calibration > Correction**

### 5.2.7 Error Correction Status

The error correction status is indicated for each trace individually.

The error correction status for each individual trace is indicated in the trace status field (See table 5.5). For trace status field description, see section 4.2.2.

Table 5.5 Trace error correction status

Symbols	Definition
<b>RO</b>	OPEN response calibration
<b>RS</b>	SHORT response calibration
<b>RT</b>	THRU response calibration
<b>OP</b>	One-path 2-port calibration
<b>F1</b>	Full 1-port calibration

If the status bar chart is not the status of error correction, the calibration for the measured parameter is missing.

### 5.2.8 System Impedance $Z_0$

$Z_0$  is the system impedance of a measurement path. Normally it is equal to the impedance of the calibration standards, which are used for calibration. The  $Z_0$  value should be specified before calibration, as it is used for calibration coefficient calculations.

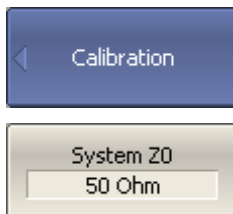

To set the system impedance  $Z_0$ , use the following softkeys:

**Calibration > System  $Z_0$**

Note

Selection of calibration kit automatically determines the system impedance in accordance with the value specified for the kit.

### 5.2.9 Port Extension

The port extension function enables you to eliminate the fixture (with or without losses) effects on the measurement results. The function virtually extends the test ports moving the calibration plane to the terminals of the DUT (by the length of the fixture). The fixture parameters are defined by the user for each port individually (See figure 5.9).

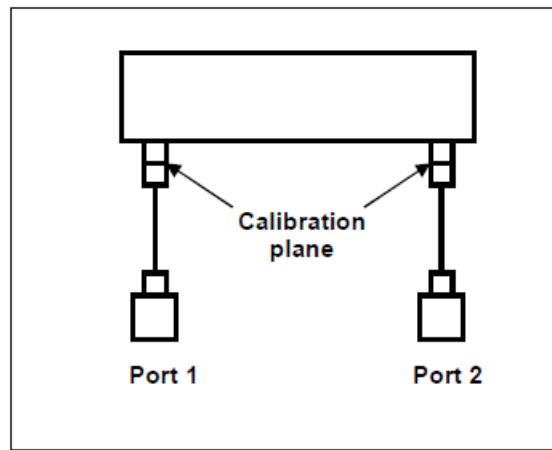

Figure 5.9 Port extension

The phase incursion caused by electrical delay is compensated for, when a lossless fixture needs to be removed:

$$e^{j \cdot 2\pi \cdot f \cdot t}, \text{ where}$$

$f$  - frequency, Hz,

$t$  - electrical delay, sec.

The feature of removing a lossless fixture is similar to the feature of electrical delay setting for a trace (See section 4.9.7), but unlike the latter it applies to all the traces of the channel. It compensates for a fixture length in transmission measurements and for a double fixture length in reflection measurements.

To remove a fixture with losses, the following methods of loss defining (in one, two or three frequency points) are applied:

1. Frequency-independent loss at DC -  $L_0$

$$L(f) = L_0$$

2. Frequency-dependent loss determined by the losses in two frequency points:  $L_0$  at DC, and  $L_1$  at frequency  $F_1$

$$L(f) = L_0 + (L_1 - L_0) \cdot \sqrt{\frac{f}{F_1}}$$

3. Frequency-dependent loss determined by the losses in three frequency points:  $L_0$  at DC,  $L_1$  at frequency  $F_1$ , and  $L_2$  at frequency  $F_2$

$$L(f) = L_0 + (L_1 - L_0) \cdot \left( \frac{f}{F_1} \right)^n, \quad n = \frac{\log \left| \frac{L_1}{L_2} \right|}{\log \left| \frac{F_1}{F_2} \right|}$$

## 5.3 Calibration Kit Management

This section describes how to edit the calibration kit description.

The Analyzer provides a table for 11 calibration kits. The first eight kits are the predefined kits. The other kits are empty templates for adding calibration standards by the user.

A calibration kit redefining can be required to precise the standard parameters to improve the calibration accuracy.

A new user-defined calibration kit adding can be added when a required kit is not included in the list of the predefined kits.

The changes made by the user to the definition of the calibration kits are saved into the nonvolatile memory of the Analyzer. For the saving no clicking on a "Save" button is required.

---

Note

Changes to a predefined calibration kit can be cancelled any time and the initial state will be restored by a **Restore Cal Kit** softkey.

---

### 5.3.1 Calibration Kit Selection for Editing

The calibration kit currently selected for calibration is the kit available for editing. This active calibration kit is selected by the user as described in section 5.2.1.

### 5.3.2 Calibration Kit Label Editing

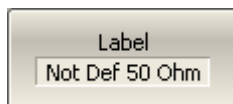
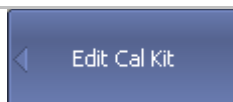

To edit the label of a calibration kit, use the following softkeys:

**Edit Cal Kit > Label**

Then enter the calibration kit label.

---

### 5.3.3 Predefined Calibration Kit Restoration

Select the required calibration kit from the list.

	<p>To cancel the user changes of a predefined calibration kit, use the following softkeys:</p>
	<p><b>Restore Cal Kit</b></p>

Note

It is possible to restore only a predefined calibration kits.

### 5.3.4 Calibration Standard Editing

	<p>To edit the calibration standard, use the following softkeys:</p>
	<p><b>Calibration &gt; Edit Cal Kit &gt;</b></p>
	<p>Then edit the parameters of the standard using the following softkeys.</p>
	<p>Standard types: SHORT, OPEN, LOAD, THRU. The standard type is determined by its parameters.</p>
	<p>For an OPEN standard, the values fringe capacitance of the OPEN model are specified. This model is described by the following polynomial of the third order:</p>
	<p><math>C = C_0 + C_1 f + C_2 f^2 + C_3 f^3</math> , where</p>
	<p>f: frequency [Hz]</p>
	<p><math>C_0...C_3</math> – polynomial coefficients</p>



L0 [e-12 H]	0
L1 [e-24 H/Hz]	0
L2 [e-33 H/Hz^2]	0
L3 [e-42 H/Hz^3]	0

For a SHORT standard, the values of the residual inductance of the SHORT model are specified. This model is described by the following polynomial of the third order:

$$L = L_0 + L_1 f + L_2 f^2 + L_3 f^3, \text{ where}$$

f : frequency [Hz]

$L_0 \dots L_3$  – polynomial coefficients

Offset Delay	17,817 ps
Offset Z0	50,209 Ohm
Offset Loss	2,1002 GOhm/s

The parameters of the transmission line of the standard model are specified for all the types of the standards.

- Offset delay value in one direction (s);
- Offset wave impedance value ( $\Omega$ );
- Offset loss value ( $\Omega/s$ ).

## 5.4 Automatic Calibration Module

Automatic calibration module (ACM) is a special device, which allows for automating of the process of calibration. ACM is shown in figure 5.10.



Figure 5.10 Automatic Calibration Module

ACM offers the following advantages over the traditional SOLT calibration, which uses a mechanical calibration kit:

- Reduces the number of connections of standards. Instead of connecting seven standards, it requires connecting only two ACM connectors;
- Reduces the calibration time;
- Reduces human error probability;
- Provides higher accuracy potentially.

ACM has two RF connectors for connection to the Analyzer test ports and a USB connector for control. ACM contains electronic switches, which switch between different reflection and transmission impedance states, as well as memory, which stores precise S-parameters of these impedance states.

After you connect the ACM to the Analyzer, the Analyzer software performs the calibration procedure automatically, i.e. switches between different ACM states, measures them, and computes calibration coefficients using the data stored in the ACM memory.

### 5.4.1 Automatic Calibration Module Features

#### **Calibration Types:**

ACM allows the Analyzer software to perform 1-Path two-port or full one-port calibrations with the click of a button. We recommend that you terminate the unusable ACM port with a load while performing one-port calibration.

#### **Characterization:**

Characterization is a table of S-parameters of all the states of the ACM switches, stored in the ACM memory. There are two types of characterization: user characterization and factory characterization. ACM has two memory sections. The first one is writeprotected and contains factory characterization. The second memory section allows you to store up to three user characterizations. Before calibration you can select the factory characterization or any of the user characterizations stored in the ACM memory. The user characterization option is provided for saving new S-parameters of the ACM after connecting adapters to the ACM ports.

#### **Automatic Orientation:**

Orientation means relating the ACM ports to the test ports of the Analyzer. While the Analyzer test ports are indicated by numbers, the ACM ports are indicated by letters A and B.

Orientation is defined either manually by the user, or automatically. The user is to select the manual or automatic orientation method. In case of automatic orientation, the Analyzer software determines the ACM orientation each time prior to its calibration or characterization.

#### **Thermal Compensation:**

The most accurate calibration can be achieved if the ACM temperature is equal to the temperature, at which it was characterized. When this temperature changes, certain ACM state parameters may deviate from the parameters stored in the memory. This results in reduction of the ACM calibration accuracy.

To compensate for the thermal error, the ACM features thermal compensation function. Thermal compensation is a software function of the ACM S-parameter correction based on its temperature dependence and the data from the temperature sensor inside the ACM. The temperature dependence of each ACM is determined at the factory and saved into its memory.

The function of thermal compensation can be enabled or disabled by the user.

#### **Confidence Check:**

ACM also implements an additional state – an attenuator, which is not used in calibration. The attenuator is used to check the current calibration performed by ACM or any other method. Such test is called a confidence check.

The confidence check consists in simultaneous display of the measured and stored in memory S-parameters of the attenuator. The measured parameters are shown as the data trace and the parameters saved in the ACM memory are shown as the memory trace. You can compare the two traces, evaluate their differences and determine the accuracy of the calibration performed.

For a detailed comparison you can use the math (division) function for data and memory.

#### 5.4.2 Automatic Calibration Procedure

Before calibrating the Analyzer with ACM, perform some settings, i.e. activate a channel and set channel parameters (frequency range, IF bandwidth, etc).

Connect the ACM to the Analyzer test ports, and connect the USB port of the ACM to the USB port of the computer.

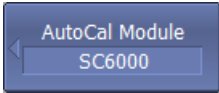
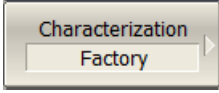
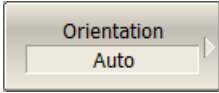
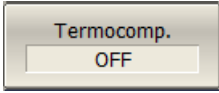
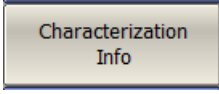
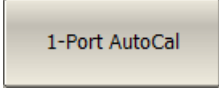
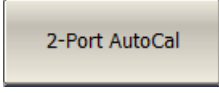
	<p>To start automatic calibration, use the following softkeys: <b>Calibration &gt; AutoCal</b></p>
	<p>Select characterization using Characterization softkey.</p>
	<p>Select manual or automatic orientation of the ACM using Orientation softkey. It is recommended to select <b>AUTO</b> orientation.</p>
	<p>Enable or disable the thermal compensation using Termocomp. softkey.</p>
	<p>To display detailed information on characterization, use Characterization Info softkey.</p>
	<p>To perform full one-port calibration, use <b>1-Port AutoCal</b> softkey.</p>
	<p>To perform 1-Path two-port calibration, use <b>2-Port AutoCal</b> softkey</p>

### 5.4.3 Confidence Check Procedure

In case you need to verify the reliability of the current calibration, perform the confidence check. This function can be used to check the accuracy of either calibration performed with an ACM or with a mechanical calibration kit.

Connect the ACM to the Analyzer test ports, and connect the USB port of the ACM to the USB port of the computer.

Enable the display of the data trace for the needed parameter, for example S<sub>21</sub>. It is possible to enable several data traces simultaneously, for example, S<sub>11</sub>, S<sub>21</sub>.

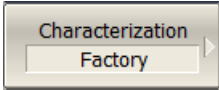
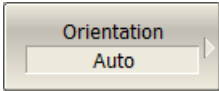
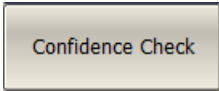
	Select characterization using Characterization softkey.
	<p>Select manual or automatic orientation of the ACM using Orientation softkey.</p> <p>It is recommended to select AUTO orientation.</p>
	Perform confidence check using <b>Confidence Check</b> softkey.

After the measurement is completed, two traces for each S-parameter will be displayed. The measured parameters will be shown as the data trace, and the ACM parameters will be shown as the memory trace.

Compare the data trace and the memory trace of the same parameter, for example S<sub>21</sub>. To perform more accurate comparison, enable the function of math operations between data and memory traces. In the logarithmic magnitude or phase format use the **Data / Memory** operation. In the linear magnitude format use the **Data – Memory** operation.

The conclusion on whether the current calibration provides sufficient accuracy or not is made by the user.

## 6 MEASUREMENT DATA ANALYSIS

### 6.1 Markers

A marker is a tool for numerical readout of a stimulus value and value of the measured parameter in a specific point on the trace. You can activate up to 16 markers on each trace. See a trace with two markers in figure 6.1.

The markers allow the user to perform the following tasks:

- Reading absolute values of a stimulus and a measured parameter in selected points on the trace;
- Reading relative values of a stimulus and a measured parameter related to the reference point;
- Search for minimum and maximum of the trace;
- Determining trace parameters (statistics, bandwidth, etc).

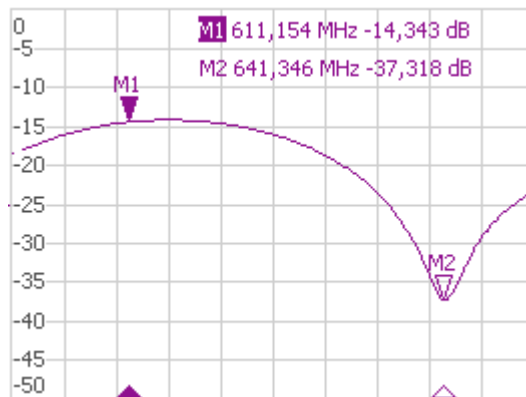

Figure 6.1

Markers can have the following indicators:

M1 ▼	symbol and number of the active marker on a trace,
M2 ▽	symbol and number of the inactive marker on a trace,
▲	symbol of the active marker on a stimulus axis,
△	symbol of the inactive marker on a stimulus axis.

The marker data field contains the marker number, stimulus value, and the measured parameter value. The number of the active marker is highlighted in inverse color.



The marker data field contents vary depending on the display format (rectangular or circular).

- In rectangular format, the marker shows the measurement parameter value plotted along Y-axis in the active format (See table 4.6).
- In circular format, the marker shows two or three values listed in table 6.1

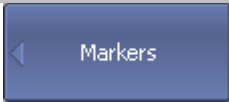

Table 6.1 Marker readings in circular formats

Label	Marker Readings (Measurement Unit)		
	Reading 1	Reading 2	Reading 3
<b>Smith (Lin)</b>	Linear magnitude	Phase ( $\angle$ )	–
<b>Smith (Log)</b>	Logarithmic magnitude (dB)	Phase ( $\angle$ )	–
<b>Smith (Re/Im)</b>	Real part	Imaginary part	–
<b>Smith (R + jX)</b>	Resistance ( $\Omega$ )	Reactance ( $\Omega$ )	Equivalent capacitance or inductance (F/H)
<b>Smith (G + jB)</b>	Conductance (S)	Susceptance (S)	Equivalent capacitance or inductance (F/H)
<b>Polar (Lin)</b>	Linear magnitude	Phase ( $\angle$ )	–
<b>Polar (Log)</b>	Logarithmic magnitude (dB)	Phase ( $\angle$ )	–
<b>Polar (Re/Im)</b>	Real part	Imaginary part	–

### 6.1.1 Marker Adding

 	<p>To enable a new marker, use the following softkeys:</p> <p><b>Markers &gt; Add Marker</b></p>
<p>Note</p>	<p>The new marker appears as the active marker in the middle of the stimulus axis. The marker stimulus value entry field activates.</p>

### 6.1.2 Marker Deleting

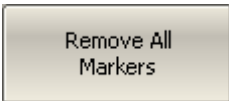
  	<p>To delete a marker, use the following softkeys:</p> <p><b>Markers &gt; Remove Marker</b></p> <p>To delete all the markers of the active trace, use the following softkeys:</p> <p><b>Markers &gt; Remove All Markers</b></p>
----------------------------------------------------------------------------------------------------------------------------------------------------------------------------------------------------------------------------------------------------------------	---------------------------------------------------------------------------------------------------------------------------------------------------------------------------------------------------------------------------------

### 6.1.3 Marker Stimulus Value Setting

Before you set the marker stimulus value, you need to select the active marker. You can set the stimulus value by entering the numerical value from the keyboard or by dragging the marker using the mouse. Drag-and-drop operation is described in section 4.3.7.

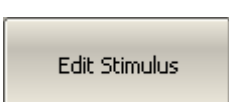
 	<p>To set the marker stimulus value, use the following softkeys:</p> <p><b>Markers &gt; Edit Stimulus</b></p> <p>or make a mouse click on the stimulus value field.</p> <p>Then enter the stimulus value.</p>
----------------------------------------------------------------------------------------------------------------------------------------------------------------------------	---------------------------------------------------------------------------------------------------------------------------------------------------------------------------------------------------------------



### 6.1.4 Marker Activating

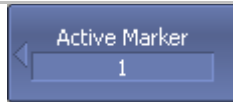

To activate a marker by its number, use the following softkeys:



**Markers > Active Marker > Marker n**

...



---

Note

You can activate a marker by making a mouse click on it.

---

### 6.1.5 Reference Marker Feature

Reference marker feature allows the user to view the data relative to the reference marker. Other marker readings are represented as delta relative to the reference marker. The reference marker shows the absolute data. The reference marker is indicated with  $\Delta$  symbol instead of a number (See figure 6.2). Enabling of a reference marker turns all the other markers to relative display mode.

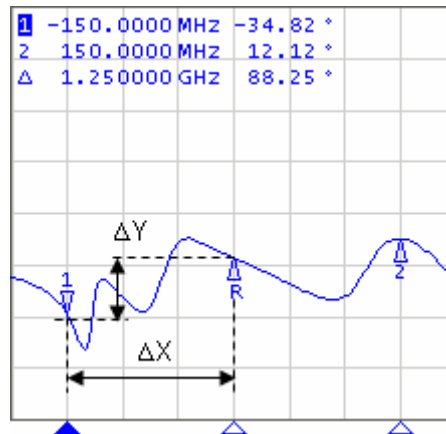

Figure 6.2

Reference marker can be indicated on the trace as follows:

R ▼	symbol of the active reference marker on a trace;
R ▽	symbol of the inactive reference marker on a trace.

The reference marker displays the stimulus and measurement absolute values. All the rest of the markers display the relative values:

- stimulus value — difference between the absolute stimulus values of this marker and the reference marker;
- measured value — difference between the absolute measurement values of this marker and the reference marker.

<div style="border: 1px solid black; background-color: #4a7ebb; color: white; padding: 5px; width: fit-content; margin-bottom: 5px;">← Markers</div> <div style="border: 1px solid black; background-color: #d3d3d3; padding: 5px; width: fit-content;">Reference Marker OFF</div>	<p>To enable/disable the reference marker, use the following softkeys:</p> <p><b>Markers &gt; Reference Marker</b></p>
----------------------------------------------------------------------------------------------------------------------------------------------------------------------------------------------------------------------------------------------------------------------------------------	------------------------------------------------------------------------------------------------------------------------

## 6.1.6 Marker Properties

- Marker Coupling Feature

The marker coupling feature enables/disables dependence of the markers of the same numbers on different traces. If the feature is turned on, the coupled markers (markers with same numbers) will move along X-axis synchronously on all the traces. If the coupling feature is off, the position of the markers with same numbers along X-axis will be independent (See figure 6.3).

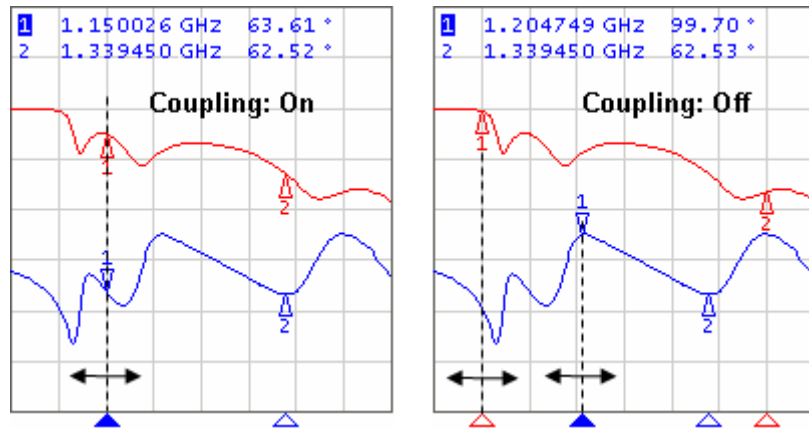
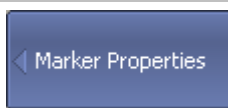

Figure 6.3 Marker coupling feature



To enable/disable the marker coupling feature, use the following softkeys:

**Markers > Properties > Marker Couple**

## ▪ Marker Value Indication Capacity

By default, the marker stimulus values are displayed with 3 decimal digits and marker response values are displayed with 3 decimal digits. The user can change these settings.

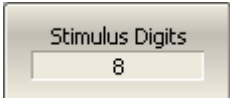
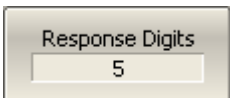
	<p>To set the marker value indication capacity, use the following softkeys:</p>
	<p><b>Markers &gt; Properties &gt; Stimulus Digits</b></p>
	<p><b>Markers &gt; Properties &gt; Response Digits</b></p>

## ▪ Multi Marker Data Display

If several overlapping traces are displayed in one graph, by default only active marker data are displayed on the screen. The user can enable display of the marker data of all the traces simultaneously. The markers of different traces will be distinguished by the color. Each marker will have same color with its trace.

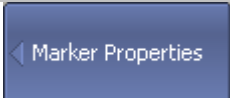
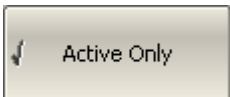
	<p>To enable/disable the multi marker data display, toggle the softkey:</p>
	<p><b>Markers &gt; Marker Properties &gt; Active Only</b></p>
<p>Note</p>	<p>When multi marker data display is enabled, to avoid data overlapping on the screen, arrange the marker data on the screen.</p>

## 6.1.7 Marker Position Search Functions

Marker position search function enables you to find on a trace the following values:

- maximum value;
- minimum value.

### 6.1.7.1 Search for Maximum and Minimum

Maximum and minimum search functions enable you to determine the maximum and minimum values of the measured parameter and move the marker to these positions on the trace (See figure 6.4).

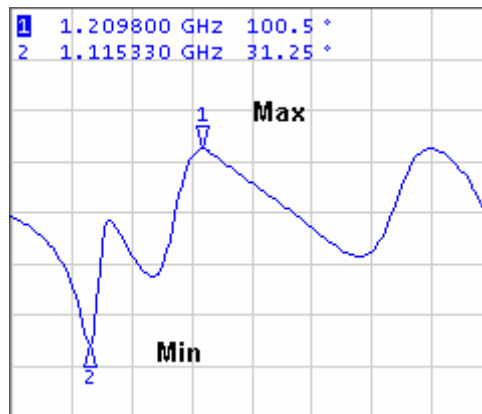
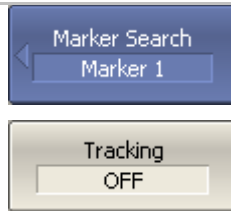

Figure 6.4 Maximum and minimum search

	<p>To find the maximum or minimum values on a trace, use the following softkeys:</p>
	<p><b>Markers &gt; Marker Search &gt; Maximum</b></p>
	<p><b>Markers &gt; Marker Search &gt; Minimum</b></p>
<p>Note</p>	<p>Before you start maximum or minimum search, first activate the marker.</p> <p>In Smith chart and polar formats the search is executed for the first value of the marker.</p>

### 6.1.7.2 Search Tracking

The marker position search function by default can be initiated by any search key pressing. Search tracking mode allows you to perform continuous marker position search, until this mode is disabled.



To enable/disable search tracking mode, use the following softkeys:

**Markers > Marker Search > Tracking**

### 6.1.7.3 Search Range

The user can set the search range for the marker position search by setting the stimulus limits. This function involves the following additional features:

- search range coupling, which allows the user to define the same search range for all the traces of a channel;
- vertical line indication of the search range limits.



To enable/disable the search range, use the following softkeys:

**Markers > Marker Search > Search Range**

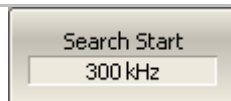

To set the search range limits, use the following softkeys:

**Markers > Marker Search > Search Start**

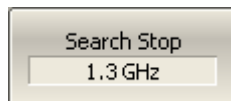

**Markers > Marker Search > Search Stop**

## 6.1.8 Marker Math Functions

Marker math functions are the functions, which use markers for calculating of various trace characteristics. Four marker math functions are available:

- Statistics;
- Bandwidth Search;
- Flatness;
- RF Filter.

### 6.1.8.1 Trace Statistics

The *trace statistics* feature allows the user to determine and view such trace parameters as mean, standard deviation, and peak-to-peak. The trace statistics range can be defined by two markers (See figure 6.5).

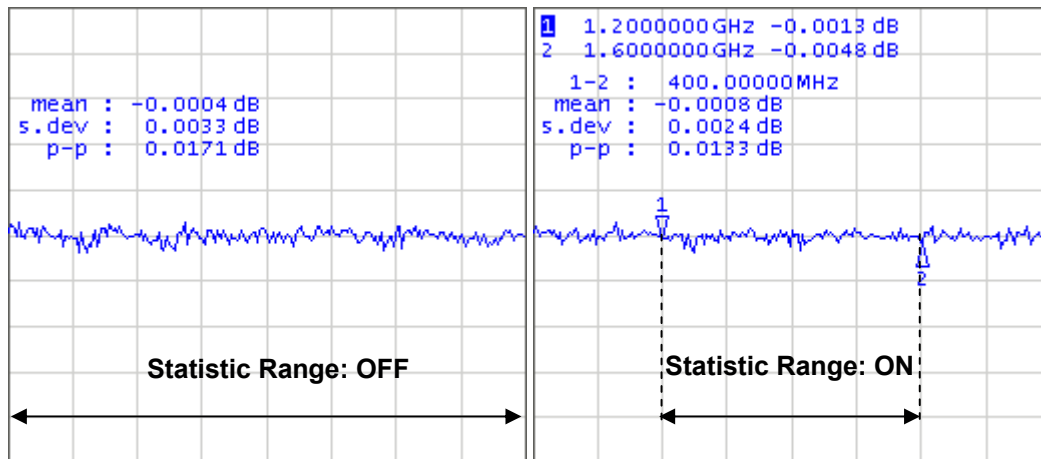
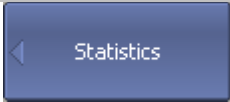
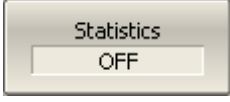
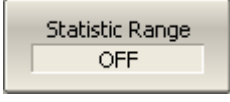
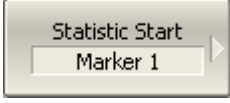
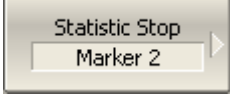

Figure 6.5 Trace statistics

Table 6.2 Statistics parameters

Symbol	Definition	Formula
<b>mean</b>	Arithmetic mean	$M = \frac{1}{N} \cdot \sum_{i=1}^N x_i$
<b>s.dev</b>	Standard deviation	$\sqrt{\frac{1}{N-1} \cdot \sum_{i=1}^N (x_i - M)^2}$
<b>p-p</b>	Peak-to-Peak: difference between the maximum and minimum values	Max – Min

	<p>To enable/disable trace statistics function, use the following softkeys:</p>
	<p><b>Markers &gt; Marker Math &gt; Statistics &gt; Statistics</b></p>
	<p>To enable/disable trace statistics range, use the following softkeys:</p>
	<p>To set the start/stop markers of the statistics range, use the following softkeys:</p>
	<p><b>Markers &gt; Marker Math &gt; Statistics &gt; Statistic Start</b></p>
	<p><b>Markers &gt; Marker Math &gt; Statistics &gt; Statistic Stop</b></p>

### 6.1.8.2 Flatness

The *flatness search* function allows the user to determine and view the following trace parameters: gain, slope, and flatness. The user sets two markers to specify the flatness search range (See figure 6.6).

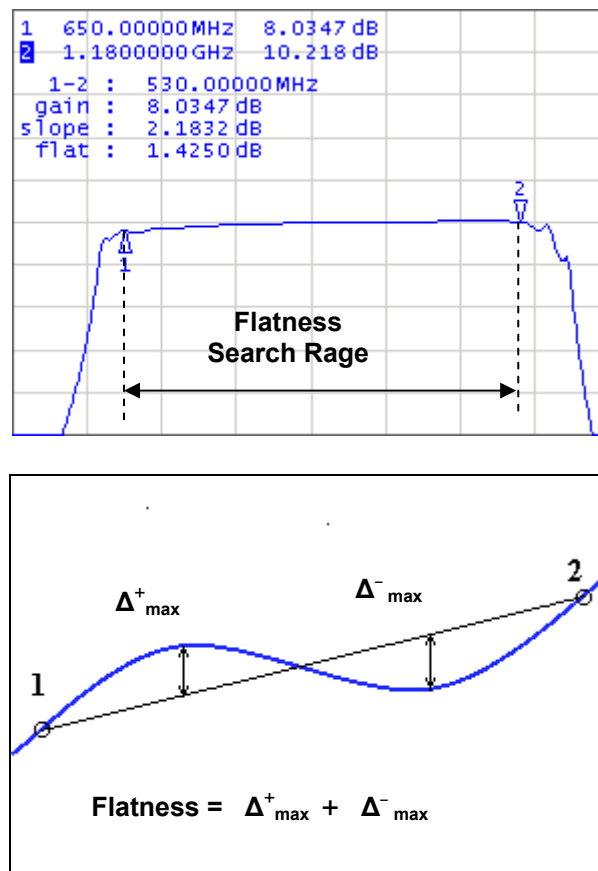
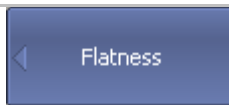

Figure 6.6 Flatness search



Table 6.3 Flatness parameters

Parameter Description	Symbol	Definition
Gain	<b>gain</b>	Marker 1 value
Slope	<b>slope</b>	Difference between marker 2 and marker 1 values.
Flatness	<b>flatness</b>	Sum of "positive" and "negative" peaks of the trace, which are measured from the line connecting marker 1 and marker 2 (See figure 6.6).



To enable/disable the flatness search function, use the following softkeys:

**Markers > Marker Math > Flatness > Flatness**

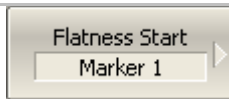
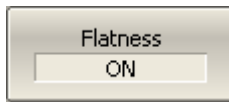

To select the markers specifying the flatness search range, use softkeys:

**Markers > Marker Math > Flatness > Flatness Start**



**Markers > Marker Math > Flatness > Flatness Stop**

## 6.2 Memory Trace Function

For each data trace displayed on the screen a so-called memory trace can be created. There can be saved up to eight memory traces for each data trace. The memory trace is displayed in the same color as the main data trace, but its brightness is lower<sup>1</sup>.

The memory trace is a data trace saved into the memory. It is created from the current measurement when the user is clicking the corresponding softkey. After that, the two traces become simultaneously displayed on the screen – the data trace and the memory trace.

The memory traces inherit the format after the data traces. Changes to this format will **clear** the memory.

The following data trace settings (if changed after the memory trace creation) do not influence the memory trace:

- frequency range,
- number of points,
- sweep type,
- power in frequency sweep mode,
- frequency in power sweep mode,
- measured parameter (S-parameter),
- IF bandwidth,
- calibration.

The memory trace can be used for math operations with the data trace. The resulting trace of such an operation will replace the data trace. The math operations with memory and data traces are performed in complex values. The following four math operations are available:

<b>Data / Memory</b>	Divides the measured data by the data in the memory trace. The trace status field indicates: <b>D/M</b> .
<b>Data * Memory</b>	Multiplies the measured data by the memory trace. The trace status field indicates: <b>D*M</b> .
<b>Data – Memory</b>	Subtracts a memory trace from the measured data. The trace status field indicates: <b>D–M</b> .
<b>Data + Memory</b>	Adds the measured data to the data in the memory trace. The trace status field indicates: <b>D+M</b> .

<sup>1</sup> The color and brightness of the data and memory traces can be customized by the user (See section 8.6).

### 6.2.1 Saving Trace into Memory

The memory trace function can be applied to the individual traces of the channel. Before you enable this function, first activate the trace.

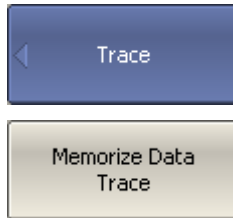

To save a trace into the memory, use the following softkeys:

**Trace > Memorize Data Trace**

To save the next trace into memory, proceed as above.

First memory trace will be saved into memory cell 1. The second memory trace will be saved into memory cell 2 etc.

### 6.2.2 Memory Trace Deleting

The memory trace deleting can be applied to the individual traces of the channel. Before you enable this function, first activate the trace.

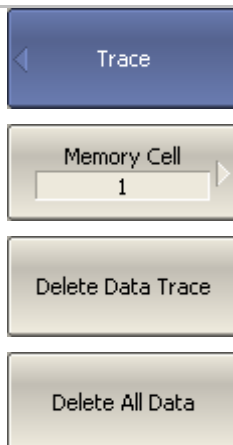

To activate a memory trace, use the following softkeys:

**Trace > Memory Cell**

To delete a memory trace, use the following softkeys:

**Trace > Delete Data Trace**

To clear all memory traces, use the following softkeys:

**Trace > Delete All Data**

### 6.2.3 Mathematical Operations

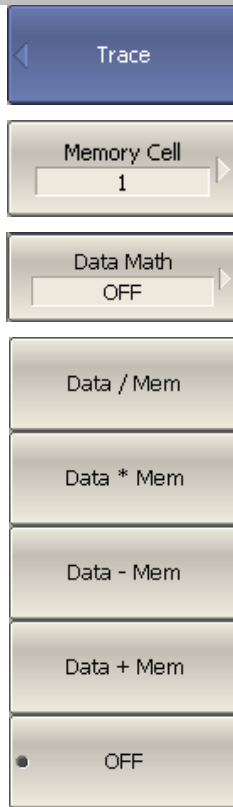

To activate a memory trace, use the following softkeys:

**Trace > Memory Cell**

To access math operations, use the following softkeys:

**Trace > Data Math >**

**Data / Mem | Data \* Mem | Data – Mem | Data + Mem | OFF**

## 6.3 Fixture Simulation

The fixture simulation function enables you to emulate the measurement conditions other than those of the real setup. The following conditions can be simulated:

- Port Z conversion;
- De-embedding;
- Embedding.

Before starting the fixture simulation, first activate the channel. The simulation function will affect all the traces of the channel.

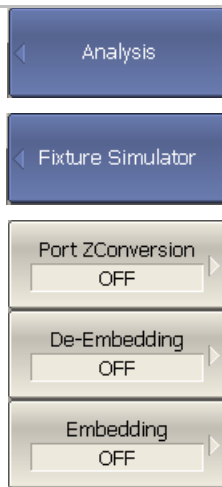

To open the fixture simulation menu, use the following softkeys:

**Analysis > Fixture Simulator > Port Z Conversion | De-Embedding | Embedding**

### 6.3.1 Port Z Conversion

Port Z conversion is a function of transformation of the S-parameters measured during port wave impedance change simulation.

#### Note

The value of the test port impedance is defined in the process of calibration. It is determined by the characteristic impedance of the calibration kit.

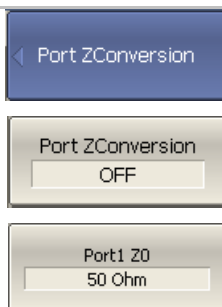

To enable/disable the port impedance conversion function, toggle **Port Z Conversion** softkey.

To enter the value of the simulated impedance of Port 1, use **Port 1 Zo** softkey.

### 6.3.2 De-embedding

De-embedding is a function of the S-parameter transformation by removing of some circuit effect from the measurement results.

The circuit being removed should be defined in the data file containing S-parameters of this circuit. The circuit should be described as a 2-port in Touchstone file (extension .s2p), which contains the S-parameter table:  $S_{11}$ ,  $S_{21}$ ,  $S_{12}$ ,  $S_{22}$  for a number of frequencies.

The de-embedding function allows to mathematically exclude from the measurement results the effect of the fixture circuit existing between the calibration plane and the DUT in the real network. The fixture is used for the DUTs, which cannot be directly connected to the test ports.

The de-embedding function shifts the calibration plane closer to the DUT, so as if the calibration has been executed of the network with this circuit removed (See figure 6.7).

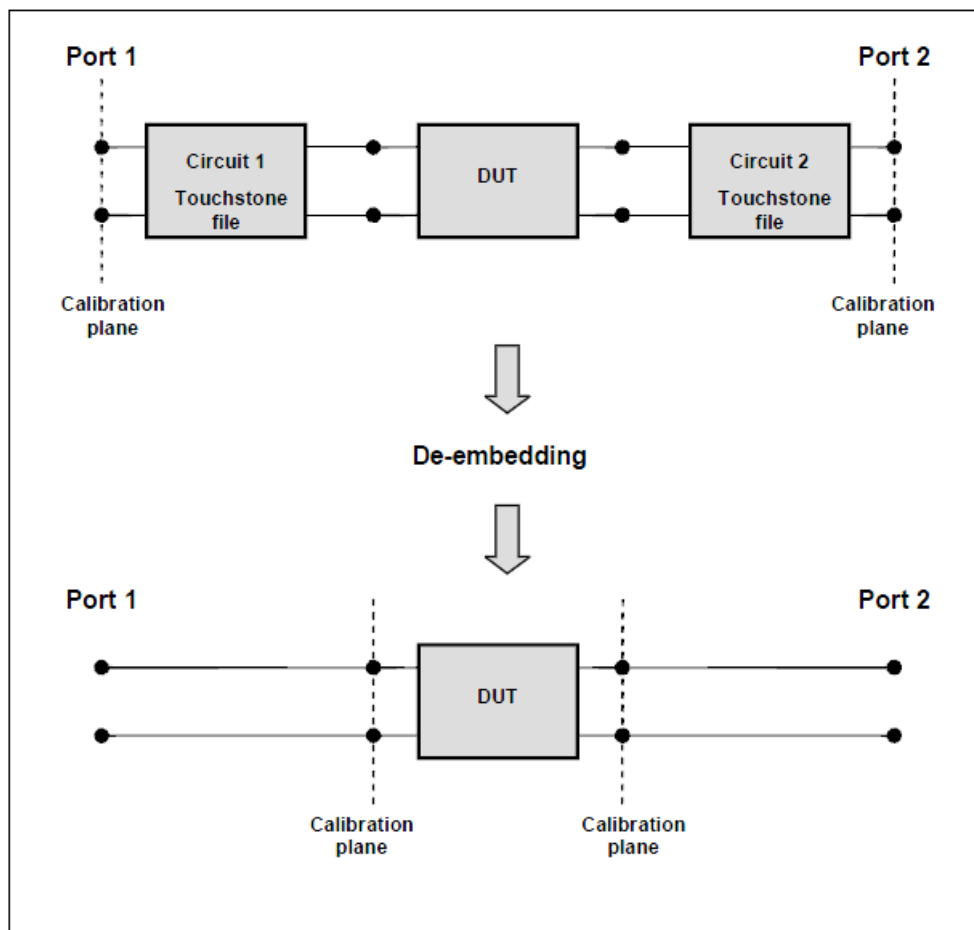
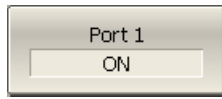

Figure 6.7 De-embedding



To enable/disable the de-embedding function for port 1, use the following softkeys:

**Analysis > Fixture Simulator > De-Embedding > Port 1.**

To enter the file name of the de-embedded circuit S – parameters of port 1, use the following softkeys:

**Analysis > Fixture Simulator > De-Embedding > S - parameters File**

#### Note

If S-parameters file is not specified, the softkey of the function activation will be grayed out.

### 6.3.3 Embedding

Embedding is a function of the S-parameter transformation by integration of some virtual circuit into the real network (See figure 6.8). The embedding function is an inverted de-embedding function.

The circuit being integrated should be defined in the data file containing S-parameters of this circuit. The circuit should be described as a 2-port in Touchstone file (extension .s2p), which contains the S-parameter table:  $S_{11}$ ,  $S_{21}$ ,  $S_{12}$ ,  $S_{22}$  for a number of frequencies.

The embedding function allows to mathematically simulate the DUT parameters after adding of the fixture circuits.

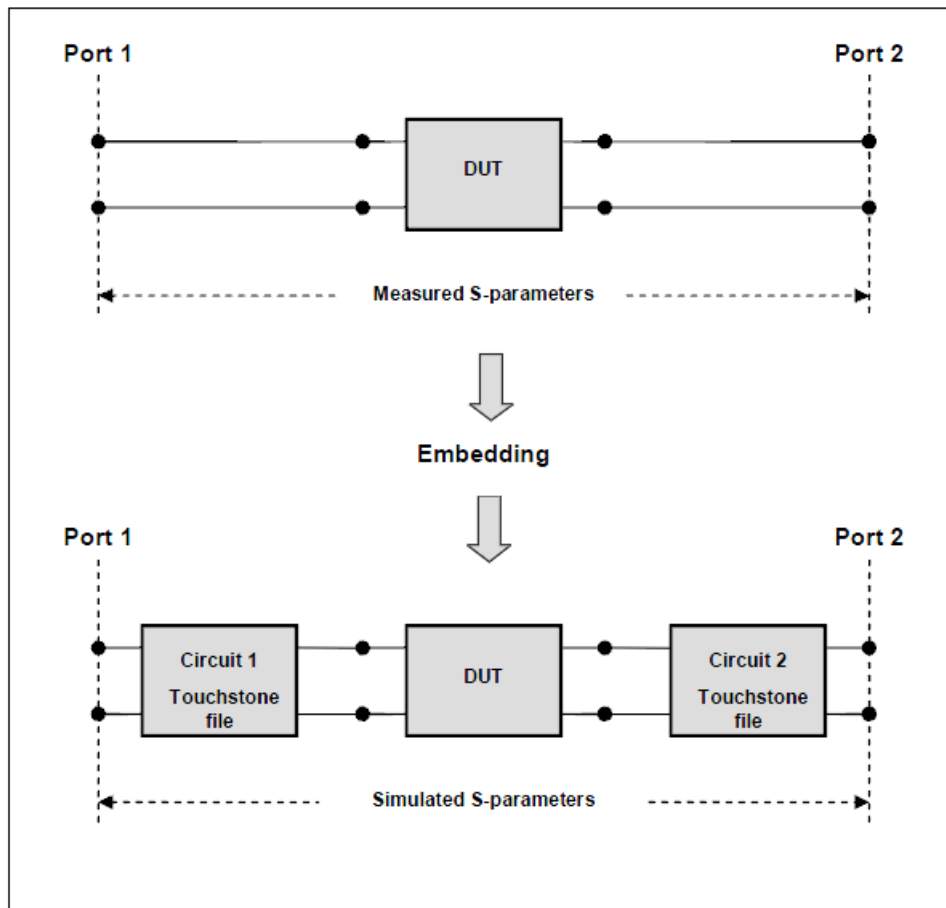
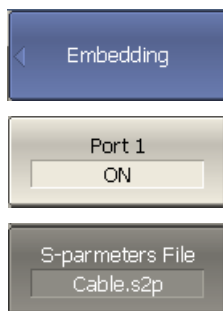

Figure 6.8 Embedding



To enable/disable the de-embedding function for port 1, use the following softkeys:

**Analysis > Fixture Simulator > Embedding > Port 1.**

To enter the file name of the de-embedded circuit S – parameters of port 1, use the following softkeys:

**Analysis > Fixture Simulator > Embedding > S - parameters File**

#### Note

If S-parameters file is not specified, the softkey of the function activation will be grayed out.



## 6.4 Time Domain Transformation

The Analyzer measures and displays parameters of the DUT in frequency domain. Time domain transformation is a function of mathematical modification of the measured parameters in order to obtain the time domain representation.

For time domain transformation Z-transformation and frequency domain window function are applied.

The time domain transformation can be activated for separate traces of a channel. The current frequency parameters ( $S_{11}$ ,  $S_{21}$ ) of the trace will be transformed into the time domain.

---

Note	Traces in frequency and time domains can simultaneously belong to one channel. The stimulus axis label will be displayed for the active trace, in frequency or time units.
------	----------------------------------------------------------------------------------------------------------------------------------------------------------------------------

---

The transformation function allows for setting of the measurement range in time domain within Z-transformation ambiguity range. The ambiguity range is determined by the measurement step in the frequency domain:

$$\Delta T = \frac{1}{\Delta F}; \quad \Delta F = \frac{F_{\max} - F_{\min}}{N - 1}$$

The time domain function allows to select the following transformation types:

- Bandpass mode simulates the impulse bandpass response. It allows the user to obtain the response for circuits incapable of direct current passing. The frequency range is arbitrary in this mode. The time domain resolution in this mode is twice lower than it is in the lowpass mode;
- Lowpass mode simulates lowpass impulse and lowpass step responses. It is applied to the circuits passing direct current, and the direct component (in point  $F=0$  Hz) is interpolated from the start frequency ( $F_{\min}$ ) of the range. In this mode the frequency range represents a harmonic grid where the frequency value at each frequency point is an integer multiple of the start frequency of the range  $F_{\min}$ . The time domain resolution is twice higher than it is in the bandpass mode.

The time domain transformation function applies Kaiser window for initial data processing in frequency domain. The window function allows to reduce the ringing (side lobes) in the time domain. The ringing is caused by the abrupt change of the data at the limits of the frequency domain. But while side lobes are reduced, the main pulse or front edge of the lowpass step becomes wider.

The Kaiser window is described by  $\beta$  parameter, which smoothly fine-tune the window shape from minimum (rectangular) to maximum. The user can fine-tune the window shape or select one of the three preprogrammed windows:

- **Minimum** (rectangular);
- **Normal**;
- **Maximum**.

Table 6.4 Preprogrammed window types

Window	Lowpass Impulse		Lowpass Step	
	Sidelobe Level	Width of the impulse (50%) <sup>*1</sup>	Sidelobe Level	Rise time (10-90%)
Minimum	-13 dB	$\frac{0.6}{F_{\max} - F_{\min}}$	-21 dB	$\frac{0.45}{F_{\max} - F_{\min}}$
Normal	-44 dB	$\frac{0.98}{F_{\max} - F_{\min}}$	-60 dB	$\frac{0.99}{F_{\max} - F_{\min}}$
Maximum	-75 dB	$\frac{1.39}{F_{\max} - F_{\min}}$	-70 dB	$\frac{1.48}{F_{\max} - F_{\min}}$

\*1. The value in the band pass mode is 2 times the value in the low pass mode.

#### 6.4.1 Time Domain Transformation Activating

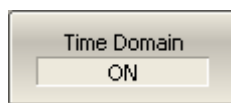
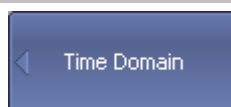

To enable/disable time domain transformation function, use the following softkeys:



**Analysis > Time Domain > Time Domain**

Note

Time domain transformation function is accessible only in linear frequency sweep mode.

### 6.4.2 Time Domain Transformation Span

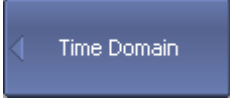
To define the span of time domain representation, you can set its start and stop, or center and span values.

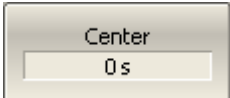
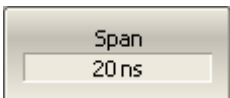
	<p>To set the start and stop limits of the time domain range, use the following softkeys:</p>
	<p><b>Analysis &gt; Time Domain &gt; Start</b></p>
	<p><b>Analysis &gt; Time Domain &gt; Stop</b></p>
	<p>To set the center and span of the time domain, use the following softkeys:</p>
	<p><b>Analysis &gt; Time Domain &gt; Center</b></p>
	<p><b>Analysis &gt; Time Domain &gt; Span</b></p>

### 6.4.3 Time Domain Transformation Type

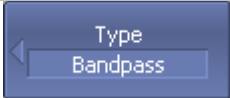
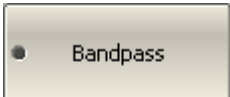
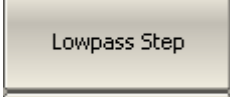
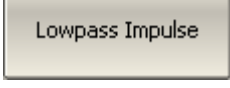
	<p>To set the time domain transformation type, use the following softkeys:</p>
	<p><b>Analysis &gt; Time Domain &gt; Type &gt;</b></p>
	<p><b>Bandpass   Lowpass Impulse   Lowpass Step</b></p>
	

### 6.4.4 Time Domain Transformation Window Shape Setting

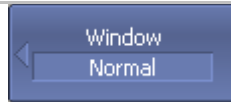

To set the window shape, use the following softkeys:

**Analysis > Time Domain > Window >**

**Minimum | Normal | Maximum**

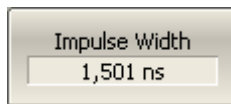
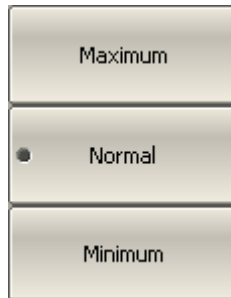

To set the window shape for the specific impulse width or front edge width, use the following softkeys:

**Analysis > Time Domain > Window > Impulse Width**

The setting values are limited by the specified frequency range. The bottom limit corresponds to the value implemented in the minimum (rectangular) window. The top limit corresponds to the value implemented in the maximum window.

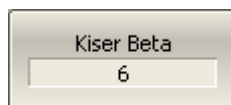

To set the window shape for the specific  $\beta$ -parameter of the Kaiser-Bessel filter, use the following softkeys:

**Analysis > Time Domain > Window > Kaiser Beta**

The available  $\beta$  values are from 0 to 13. 0 corresponds to minimum window, 6 corresponds to normal window, 13 corresponds to maximum window.

Note

The impulse width and  $\beta$  of the Kaiser-Bessel filter are the dependent parameters. When you set one of the parameters the other one will be adjusted automatically.

### 6.4.5 Frequency Harmonic Grid Setting

If lowpass impulse or lowpass step transformation is enabled, the frequency range will be represented as a harmonic grid. The frequency values in measurement points are integer multiples of the start frequency  $F_{min}$ . The Analyzer is capable of creating a harmonic grid for the current frequency range automatically.

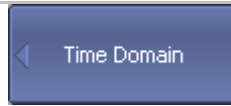

To create a harmonic grid for the current frequency range, use the following softkeys:

**Analysis > Time Domain > Set Frequency Low Pass**

The frequency range will be transformed as follows:

Note

$F_{max} > N \times 0.02 \text{ MHz}$	$F_{max} < N \times 0.02 \text{ MHz}$
$F_{min} = F_{max} / N$	$F_{min} = 0.02 \text{ MHz},$ $F_{max} = N \times 0.02 \text{ MHz}$

## 6.5 Time Domain Gating

Time domain gating is a function, which mathematically removes the unwanted responses in time domain. The function performs time domain transformation and applies reverse transformation back to frequency domain to the user-defined span in time domain. The function allows the user to remove spurious effects of the fixture devices from the frequency response, if the useful signal and spurious signal are separable in time domain.

---

Note

Use *time domain* function for viewing the layout of useful and spurious responses. Then enable *time domain gating* and set the gate span to remove as much of spurious response as possible. After that disable the time domain function and view the response without spurious effects in frequency domain.

---

The function involves two types of time domain gating:

- *bandpass* – removes the response outside the gate span,
- *notch* – removes the response inside the gate span.

The rectangular window shape in frequency domain leads to spurious sidelobes due to sharp signal changes at the limits of the window. The following gate shapes are offered to reduce the sidelobes:

- *maximum;*
- *wide;*
- *normal;*
- *minimum.*

The minimum window has the shape close to rectangular. The maximum window has more smoothed shape. From minimum to maximum window shape, the sidelobe level increases and the gate resolution reduces. The choice of the window shape is always a trade-off between the gate resolution and the level of spurious sidelobes. The parameters of different window shapes are represented in table 6.5.

Table 6.5 Time domain gating window shapes

Window Shape	Bandpass Sidelobe Level	Gate Resolution (Minimum Gate Span)
Minimum	-48 dB	$\frac{2.8}{F_{\max} - F_{\min}}$
Normal	-68 dB	$\frac{5.6}{F_{\max} - F_{\min}}$
Wide	-57 dB	$\frac{8.8}{F_{\max} - F_{\min}}$
Maximum	-70 dB	$\frac{25.4}{F_{\max} - F_{\min}}$

### 6.5.1 Time Domain Gate Activating

	<p>To enable/disable the time domain gating function: toggle the following softkey:</p> <p><b>Analysis &gt; Gating &gt; Gating</b></p>
<p>Note</p>	<p>Time domain gating function is accessible only in linear frequency sweep mode.</p>

### 6.5.2 Time Domain Gate Span

To define the span of time domain gate, you can set its start and stop, or center and span values.

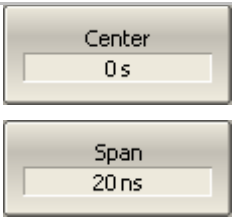
	<p>To the start and stop of the time domain gate, use the following softkeys:</p> <p><b>Analysis &gt; Gating &gt; Start</b></p> <p><b>Analysis &gt; Gating &gt; Stop</b></p>
	<p>To set the center and span of the time domain gate, use the following softkeys:</p> <p><b>Analysis &gt; Gating &gt; Center</b></p> <p><b>Analysis &gt; Gating &gt; Span</b></p>

### 6.5.3 Time Domain Gate Type

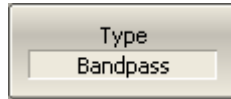
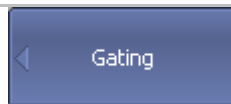

To select the type of the time domain window, use the following softkeys:

**Analysis > Gating > Type**

Toggle the type between **Bandpass** and **Notch**.

### 6.5.4 Time Domain Gate Shape Setting

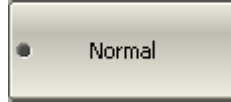
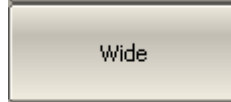
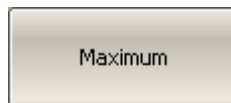
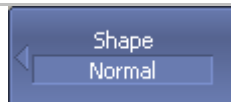

To set the time domain gate shape, use the following softkeys:

**Analysis > Gating > Shape >**

**Minimum | Normal | Wide | Maximum**



## 6.6 S-Parameter Conversion

S-parameter conversion function allows conversion of the measurement results ( $S_{11}$  or  $S_{21}$ ) to the following parameters:

- Equivalent impedance ( $Z_r$ ) and equivalent admittance ( $Y_r$ ) in reflection measurement:

$$Z_r = Z_0 \cdot \frac{1 + S_{11}}{1 - S_{11}}$$

$$Y_r = \frac{1}{Z_r}$$

- Equivalent impedance ( $Z_t$ ) and equivalent admittance ( $Y_t$ ) in transmission measurement:

$$Z_t = \frac{2 \cdot \sqrt{Z_0 \cdot Z_0}}{S_{21}} - (Z_0 + Z_0)$$

$$Y_t = \frac{1}{Z_t}$$

- Inverse S-parameter ( $1/S$ ) for reflection and transmission measurements respectively:

$$\frac{1}{S_{11}} \text{ and } \frac{1}{S_{21}}$$

- S-parameter complex conjugate.

S-parameter conversion function can be applied to an individual trace of a channel. Before enabling the function, first activate the trace.

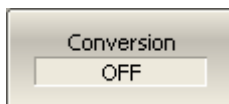
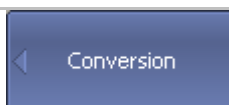

To enable/disable the conversion, use the following softkeys:

**Analysis > Conversion > Conversion**

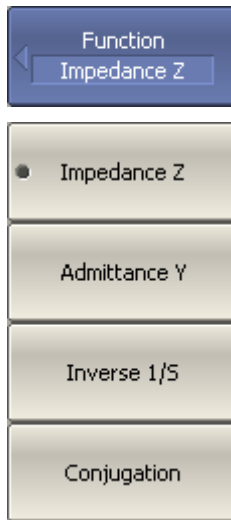

To select the conversion type, use the following softkeys:

**Analysis > Conversion > Function >**

**Impedance Z |**

**Admittance Y |**

**Inverse 1/S |**

**Conjugation**

---

Note

All conversion types are indicated in the trace status field, if enabled.

---

## 6.7 Limit Test

The limit test is a function of automatic pass/fail judgment for the trace of the measurement result. The judgment is based on the comparison of the trace to the limit line set by the user.

The limit line can consist of one or several segments (See figure 6.8). Each segment checks the measurement value for failing whether upper or lower limit. The limit line segment is defined by specifying the coordinates of the beginning ( $X_0$ ,  $Y_0$ ) and the end ( $X_1$ ,  $Y_1$ ) of the segment, and type of the limit. The MAX or MIN limit types check if the trace falls outside of the upper or lower limit respectively.

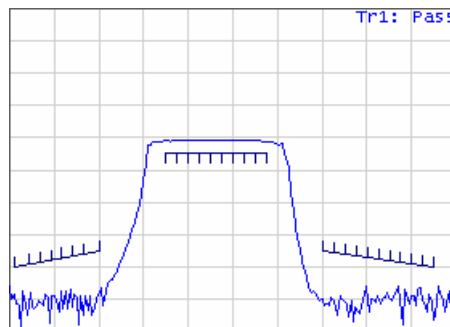

Figure 6.8 Limit line

The limit line is set by the user in the limit table. Each row in the table describes one segment of the line. Limit table editing is described below. The table can be saved into a \*.lim file.

The display of the limit lines on the screen can be turned on/off independently of the status of the limit test function.

The result of the limit test is indicated in the center of the window.

If the measurement result failed **Fail** sign will be displayed in red, otherwise **Pass** sign will be displayed in green

## 6.7.1 Limit Line Editing

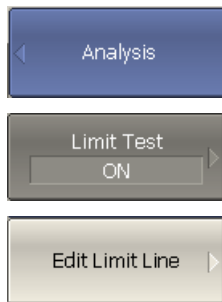

To access the limit line editing mode, use the following softkeys:

**Analysis > Limit Test > Edit Limit Line**

In the editing mode the limit table will appear in the lower part of the screen (See figure 6.g). The limit table will be hidden when you quit the submenu.

	Begin Stimulus	End Stimulus	Begin Response	End Response	Type
1	450,00000 MHz	700,00000 MHz	-20,000 dB	-20,000 dB	Max
2	800,00000 MHz	1300,0000 MHz	-1,0000 dB	-1,0000 dB	Min

Figure 6.g Limit line table

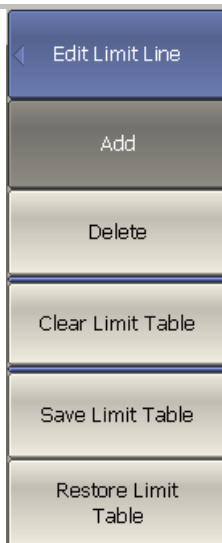

To add a new row in the table, click **Add**. The new row will appear below the highlighted one.

To delete a row from the table, click **Delete**. The highlighted row will be deleted.

To clear the entire table, use **Clear Limit Table** softkey.

To save the table into \*.lim file, use **Save Limit Table** softkey.

To open the table from a \*.lim file, use **Restore Limit Table** softkey.

Navigating in the table to enter the values of the following parameters of a limit test segment:

<b>Type</b>	Select the segment type among the following: <ul style="list-style-type: none"> <li>▪ <b>MAX</b> – upper limit</li> <li>▪ <b>MIN</b> – lower limit</li> <li>▪ <b>OFF</b> – segment not used for the limit test</li> </ul>
<b>Begin Stimulus</b>	Stimulus value in the beginning point of the segment
<b>End Stimulus</b>	Stimulus value in the ending point of the segment
<b>Begin Response</b>	Response value in the beginning point of the segment
<b>End Response</b>	Response value in the ending point of the segment.

### 6.7.2 Limit Test Enabling/Disabling

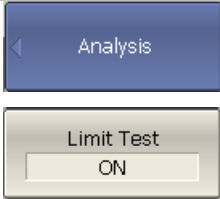
	<p>To enable/disable limit test function, use the following softkeys:</p> <p><b>Analysis &gt; Limit Test &gt; Limit Test</b></p>
-------------------------------------------------------------------------------------	----------------------------------------------------------------------------------------------------------------------------------

### 6.7.3 Limit Test Display Management

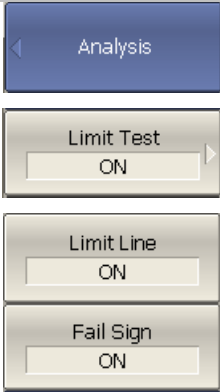
	<p>To enable/disable display of a <i>limit line</i>, use the following softkeys:</p> <p><b>Analysis &gt; Limit Test &gt; Limit Line</b></p> <p>To enable/disable display of <b>Fail sign</b> in the center of the graph, use <b>Fail Sign</b> softkey</p>
-------------------------------------------------------------------------------------	-----------------------------------------------------------------------------------------------------------------------------------------------------------------------------------------------------------------------------------------------------------

## 6.7.4 Limit Line Offset

Limit line offset function allows the user to shift the segments of the limit line by the specified value along X and Y axes simultaneously

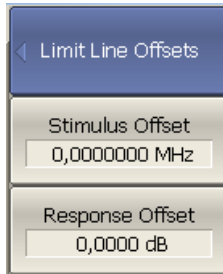

To define the limit line offset along X-axis, use the following softkeys:

**Analysis > Limit Test > Limit Line Offsets > Stimulus Offset**

To define the limit line offset along Y-axis, use the following softkeys:

**Analysis > Limit Test > Limit Line Offsets > Response Offset**

## 6.8 Ripple Limit Test

Ripple limit test is an automatic pass/fail check of the measured trace data. The trace is checked against the maximum ripple value (*ripple limit*) defined by the user. The ripple value is the difference between the maximum and minimum response of the trace in the trace frequency band.

The ripple limit can include one or more segments (See figure 6.10). Each segment provides the ripple limit for the specific frequency band. A segment is set by the frequency band and the ripple limit value.

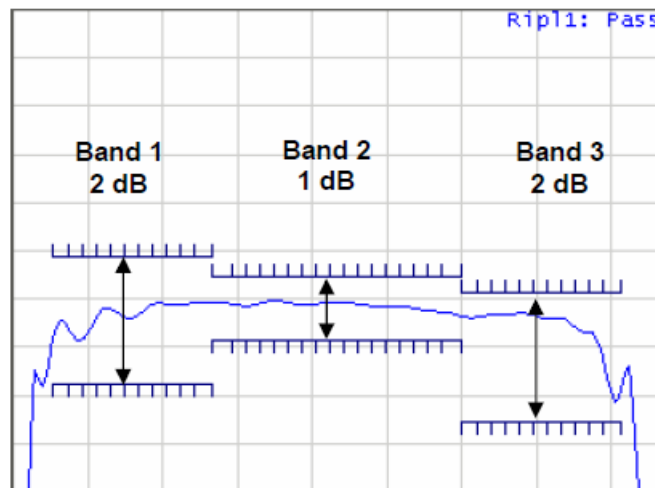

Figure 6.10 Ripple limits



The ripple limit settings are performed in the ripple limit table. Each row of the table describes the frequency band the ripple limit value. The ripple limit table editing is described below. The table can be saved into a \*.lim file.

The display of the limit lines on the screen can be turned on/off by the user.

If the measurement result failed, **Fail** sign will be displayed in red in the center of the window.

## 6.8.1 Ripple Limit Editing

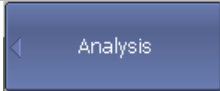
---

  	<p>To access the ripple limit editing mode, use the following softkeys:</p> <p><b>Analysis &gt; Ripple Limit &gt; Edit Ripple Limit</b></p>
-------------------------------------------------------------------------------------------------------------------------------------------------------------------------------------------------------------------------------------------------------------	---------------------------------------------------------------------------------------------------------------------------------------------



---

In the editing mode the limit table will appear in the lower part of the screen (See figure 6.11). The limit table will be hidden when you quit the submenu.

	Begin Stimulus	End Stimulus	Ripple Limit	Type
1	0,3000000 MHz	300,00000 MHz	0,1000 dB	On
2	800,00000 MHz	1300,0000 MHz	0,3000 dB	On

Figure 6.11 Ripple limit table

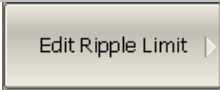
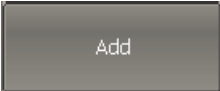
---

  	<p>To add a new row in the table, click <b>Add</b>. The new row will appear below the highlighted one.</p> <p>To delete a row from the table, click <b>Delete</b>. The highlighted row will be deleted.</p>
-------------------------------------------------------------------------------------------------------------------------------------------------------------------------------------------------------------------------------------------------------------------	-------------------------------------------------------------------------------------------------------------------------------------------------------------------------------------------------------------

---

	<p>To clear the entire table, use <b>Clear Ripple Limit Table</b> softkey.</p>
-------------------------------------------------------------------------------------	--------------------------------------------------------------------------------

---

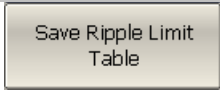
	<p>To save the table into *.rlm file, use <b>Save Ripple Limit Table</b> softkey</p>
-------------------------------------------------------------------------------------	--------------------------------------------------------------------------------------

---

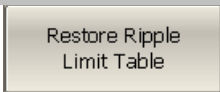
	<p>To open the table from a *.rlm file, use <b>Recall Ripple Limit Table</b> softkey</p>
-------------------------------------------------------------------------------------	------------------------------------------------------------------------------------------

---

Navigating in the table to enter the values of the following parameters of a ripple limit test segment:

<b>Type</b>	Select the segment type among the following: <ul style="list-style-type: none"> <li>▪ <b>ON</b> – band used for the ripple limit test</li> <li>▪ <b>OFF</b> – band not used for the limit test</li> </ul>
<b>Begin Stimulus</b>	Stimulus value in the beginning point of the segment
<b>End Stimulus</b>	Stimulus value in the ending point of the segment
<b>Ripple Limit</b>	Ripple limit value

### 6.8.2 Ripple Limit Enabling/Disabling

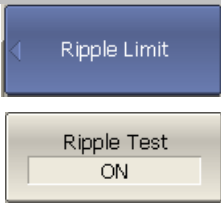
	<p>To enable/disable ripple limit test function, use the following softkeys:</p> <p><b>Analysis &gt; Ripple Limit &gt; Ripple Test</b></p>
------------------------------------------------------------------------------------	--------------------------------------------------------------------------------------------------------------------------------------------

### 6.8.3 Ripple Limit Test Display Management

	<p>To enable/disable display of the <i>ripple limit line</i>, use the following softkeys:</p> <p><b>Analysis &gt; Ripple Limit &gt; Limit Line</b></p> <p>To enable/disable display of the <b>Fail sign</b> in the center of the graph, use the following softkeys:</p> <p><b>Analysis &gt; Ripple Limit &gt; Fail Sign</b></p>
-------------------------------------------------------------------------------------	---------------------------------------------------------------------------------------------------------------------------------------------------------------------------------------------------------------------------------------------------------------------------------------------------------------------------------



## 7 ANALYZER DATA OUTPUT

### 7.1 Analyzer State

The Analyzer state, calibration, measured data and memory traces can be saved on the hard disk to an Analyzer state file and later uploaded back into the Analyzer program. The following three types of saving are available:

<b>State</b>	The Analyzer settings.
<b>State &amp; Cal</b>	The Analyzer settings and the table of calibration coefficients.
<b>State &amp; Trace</b>	The Analyzer settings and data traces.
<b>All</b>	The Analyzer settings, the table of calibration coefficients and data traces.
<b>Calibration</b>	The table of calibration coefficients.

The Analyzer settings that become saved into the Analyzer state file are the parameters, which can be set in the following submenus of the softkey menu:

- All the parameters in **Stimulus** submenu;
- All the parameters in **Response** submenu;
- All the parameters in **Scale** submenu;
- All the parameters in **Calibration** submenu;
- All the parameters in **Channel** submenu;
- All the parameters in **Trace** submenu;
- All the parameters of **Markers** submenu;
- All the parameters of **Analysis** submenu;
- All the parameters in **Display** submenu.

### 7.1.1 Analyzer State Saving

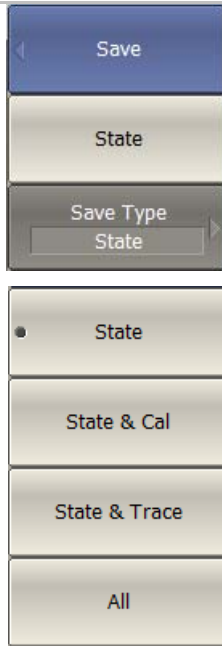

To set the type of saving, use the following softkeys:

**System > Save > State Type > State | State & Cal | State & Trace | All**

**System > Save > State**

Enter the state file name in the dialog that appears.

### 7.1.2 Analyzer State Recalling

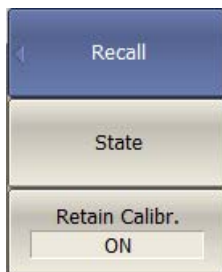

To recall the state from a file of Analyzer state, use the following softkeys:

**System > Recall > State**

Select the state file name in the pop up dialog.

By default, when the state is recalling, the program resets table of calibration coefficients. To retain the current table of calibration coefficients, use the following softkeys **Retain Calibr.**

Retain calibration works only for the saved types **State** or **State & Trace**.

## 7.2 Trace Data CSV File

The Analyzer allows the use to save an individual trace data as a CSV file (comma separated values). The \*.CSV file contains digital data separated by commas. The active trace stimulus and response values in current format are saved to \*.CSV file.

Only one (active) trace data are saved to the file.

The trace data are saved to \*.CSV in the following format:

<b>F[0],</b>	<b>Data1,</b>	<b>Data2</b>
<b>F[1],</b>	<b>Data1,</b>	<b>Data2</b>
	...	
<b>F[N],</b>	<b>Data1,</b>	<b>Data2</b>

**F[n]** – frequency at measurement point n;

**Data1** – trace response in rectangular format, real part in Smith chart and polar format;

**Data2** – zero in rectangular format, imaginary part in Smith chart and polar format.

### 7.2.1 CSV File Saving/Recalling

To save the trace data, first activate the trace.

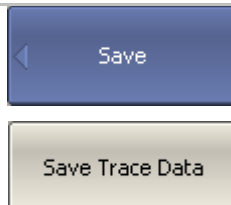

To save the trace data, use the following softkeys:

**Save/Recall > Save Trace Data**

Enter the file name in the dialog that appears.

### 7.3 Trace Data Touchstone File

The Analyzer allows the user to save S-parameters to a Touchstone file. The Touchstone file contains the frequency values and S-parameters. The files of this format are typical for most of circuit simulator programs.

The \*.s2p files are used for saving four S-parameters of a 2-port device.

The \*.s1p files are used for saving the parameters of a 1-port device.

Only one active channel data are saved to the file.

---

Note	The Analyzer allows measurement of only $S_{11}$ and $S_{21}$ parameters. When *.s2p is saved, the missing S-parameters $S_{12}$ and $S_{22}$ are filled in as zeroes.
------	------------------------------------------------------------------------------------------------------------------------------------------------------------------------

---

The Touchstone file saving function is applied to individual channels. To use this function, first activate the channel.

The Touchstone file contains comments, header, and trace data lines. Comments start from «!» symbol. Header starts from «#» symbol.

The \*.s1p Touchstone file for 1-port measurements:

```
! Comments
# Hz S FMT R Zo
F[1]  {S11}'  {S11}''
F[2]  {S11}'  {S11}''
...
F[N]  {S11}'  {S11}''
```

The \*.s2p Touchstone file for 2-port measurements:

```
! Comments
# Hz S FMT R Zo
F[1]  {S11}'  {S11}''  {S21}'  {S21}''  o  o  o  o
F[2]  {S11}'  {S11}''  {S21}'  {S21}''  o  o  o  o
...
F[N]  {S11}'  {S11}''  {S21}'  {S21}''  o  o  o  o
```

**Hz** – frequency measurement units (**kHz**, **MHz**, **GHz**)

**FMT** – data format:

- **RI** – real and imaginary parts,
- **MA** – linear magnitude and phase in degrees,
- **DB** – logarithmic magnitude in dB and phase in degrees.

**Zo** – reference impedance value

**F[n]** – frequency at measurement point n

{...}' – {real part (RI) | linear magnitude (MA) | logarithmic magnitude (DB)}

{...}'' – {imaginary part (RI) | phase in degrees (MA) | phase in degrees (DB)}

### 7.3.1 Touchstone File Saving

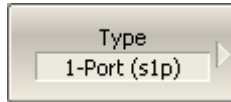
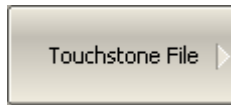

To select the saving type, use the following softkeys:  
**System > Save > Touchstone > File > Type > 1-Port (s1p) | 2-Port (s2p)**

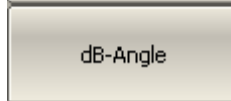
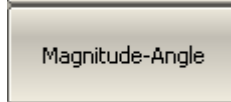
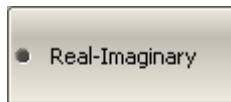
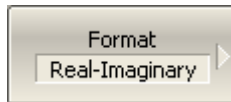
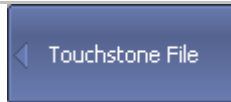

To select the data format, use the following softkeys:  
**System > Save > Touchstone File > Format > RI | MA | DB**

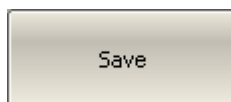

To save the file to the hard disk, use the following softkeys:

**System > Save > Touchstone File > Save**

Enter the file name in the pop up dialog.

### 7.3.2 Touchstone File Recalling

The touchstone file can be loaded from disk into trace memory and to the S-parameters. While loading data are interpolated for the current frequency range. While loading to the S-parameters the scanning is stopped not to overwrite these data.

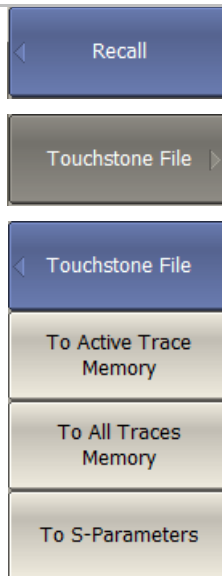

To recall the file from the hard disk, use the following softkeys:

**System > Recall > Touchstone File > To Active Trace Memory | To All Trace Memory | To S-Parameters**

Enter the file name in the pop up dialog.

## 8 SYSTEM SETTINGS

### 8.1 Analyzer Presetting

Analyzer presetting feature allows the user to restore the default settings of the Analyzer.

The default settings of your Analyzer are specified in Appendix 1.



To preset the Analyzer, use the following softkeys:

**System > Preset > Apply**

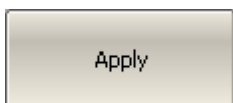

---

### 8.2 Graph Printing

This section describes the print/save procedures for the graph data.

The print function is provided with the preview feature, which allows the user to view the image to be printed on the screen, and/or save it to a file.

You can print out the graphs using three different applications:

- MS Word;
- Image Viewer for Windows;
- Print Wizard of the Analyzer.

---

Note

MS Word application must be installed in Windows system.

---

Note

The Print Wizard requires at least one printer to be installed in Windows.

---

You can select the print color before the image is transferred to the printing application:

- Color (no changes);
- Gray Scale;
- Black & White.

You can invert the image before it is transferred to the printing application.



You can add current date and time before the image is transferred to the printing application.

---

To print a graph, use the following softkeys:



**System > Print**

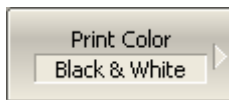

Select the print color, using **Print Color** softkey:

- **Color**
- **Gray Scale**
- **Black & White**

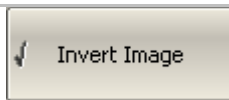

If necessary, invert the image by **Invert Image** softkey.

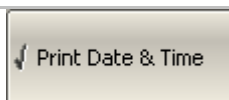

If necessary, select printing of date and time by **Print Date & Time** softkey.

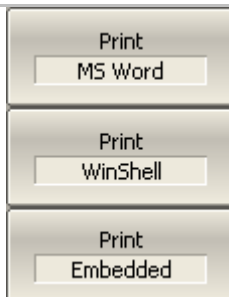

Then select the printing application, using one of the following softkeys:

- **Print: MS Word**
  - **Print: WinShell**
  - **Print: Embedded**
-

### 8.3 User Interface Setting

The Analyzer enables you to make the following user interface settings:

- Toggle between full screen and window display
- Set color of:
  - Data traces
  - Memory traces
  - Background and grid of graph
  - Font and X axis
- Width of:
  - Data traces
  - Memory traces
  - Graph grid
- Font size of:
  - Channel window
- Invert color of graph area
- Hide/show menu bar

---

#### Note

The Analyzer can be preset to the default factory settings by a specific softkey.

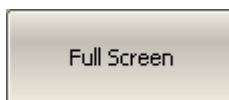
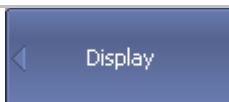

To toggle between full screen and window display, use the following softkeys:

**Display > Full Screen**

---

To change the color of the active data trace, use the following softkeys:

**Display > Color > Data Trace**

Then select the color in the window that appears.

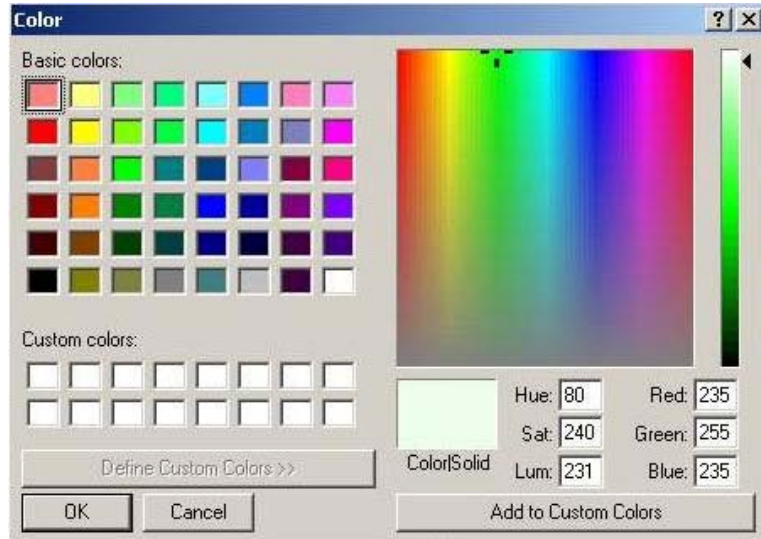
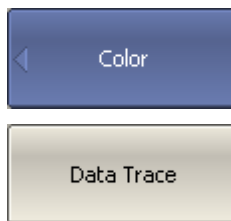

The changes made to the color of the active data traces will affect all the traces with the same number in other channels.



To change the color of the active memory trace, use the following softkeys:

**Display > Color > Memory Trace**

Then select the color in the window that appears.

The changes made to the color of the active memory traces will affect all the traces with the same number in other channels.

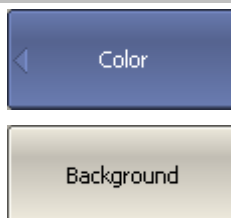

To change the color of the background of the graph, use the following softkeys:

**Display > Color > Background**

Then select the color in the window that appears.



To change the color of the grid of the graph, use the following softkeys:

**Display > Color > Grid**

Then select the color in the window that appears.

To change the width of a data trace, use the following softkeys:

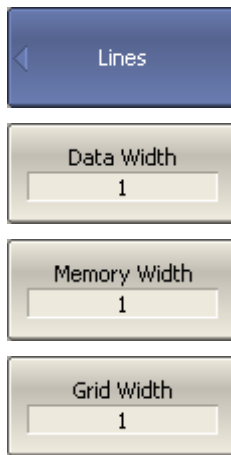

**Display > Lines > Data Trace Width**

To change the width of a memory trace, use the following softkeys:

**Display > Lines > Mem Trace Width**

To change the grid line width, the following softkeys:

**Display > Lines > Grid Style**

The changes made to the width of the lines will affect all the channels.

The width can be set from 1 to 4.

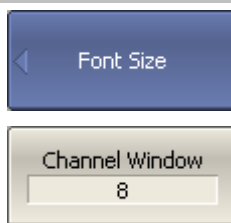

To change the font size in the channel window, use the following softkeys:

**Display > Font Size > Window Channel**

Then select the font size from 8 to 24.



To invert the color of the graph area, use the following softkeys:

**Display > Invert Color**



To hide/show the menu bar, use the following softkeys:

**Display > Menu Bar**



To restore the default factory settings, use the following softkeys:

**Display > Set Defaults**

## 8.4 Reference Frequency Oscillator Selection

The Analyzer can operate either with internal or with external reference frequency (10 MHz) oscillator. Initially the Analyzer is set to operation with the internal source of the reference frequency.

You can switch between these two modes in the softkey menu.

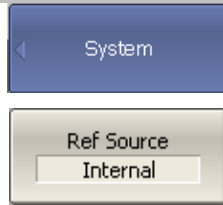

To select the reference frequency oscillator, use the following softkeys:

**System > Ref Source**

## 8.5 System Correction Setting

The Analyzer is supplied from the manufacturer calibrated with the calibration coefficients stored in its non-volatile memory. The factory calibration is used by default for initial correction of the measured S-parameters. Such calibration is referred to as system calibration, and the error correction is referred to as system correction.

The system correction ensures initial values of the measured S-parameters before the Analyzer is calibrated by the user. The system calibration is performed at the plane of the port physical connectors and leaves out of account the cables and other fixture used to connect the DUT. The measurement accuracy of the Analyzer without its calibration with the user setup is not rated.

Normally, the disabling of the system correction **is not required** for a calibration and further measurements.

The system correction can be disabled only in case the user provided a proper calibration for the Analyzer. The measurement accuracy is determined by user calibration and does not depend on the system correction status. The only rule that should be observed is to disable/enable the system correction before the user calibration, so that the calibration and further measurement could be performed under the same conditions.

If the system correction is disabled by the user, this is indicated in the instrument status bar:

System Correction Off

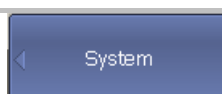

To disable/enable the system correction, use the following softkeys:

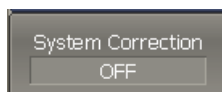

**System > System Correction**

## 9 MAINTENANCE AND STORAGE

### 9.1 Maintenance Procedures

This section describes the guidelines and procedures of maintenance, which will ensure fault-free operation of your Analyzer.

The maintenance of the Analyzer consists in cleaning of the instrument, factory calibrations, and regular performance tests.

#### 9.1.1 Instrument Cleaning

This section provides the cleaning instructions required for maintaining the proper operation of your Analyzer.

To remove contamination from parts other than test ports and any connectors of the Analyzer, wipe them gently with a soft cloth that is dry or wetted with a small amount of water and wrung tightly.

It is essential to keep the test ports always clean as any dust or stains on them can significantly affect the measurement capabilities of the instrument. To clean the test ports (as well as other connectors of the Analyzer), use the following procedure:

- using compressed air remove or loosen the contamination particles;
- clean the connectors using a lint-free cleaning cloth wetted with a small amount of ethanol and isopropyl alcohol (when cleaning a female connector, avoid snagging the cloth on the center conductor contact fingers by using short strokes);
- dry the connector with low-pressure compressed air.

Always completely dry a connector before using it.

Never use water or abrasives for cleaning any connectors of the Analyzer.

Do not allow contact of alcohol to the surface of the insulators of the connectors.

When connecting male-female coaxial connectors always use a calibrated wrench.

#### 9.1.2 Factory Calibration

Factory calibration is a regular calibration performed by the manufacturer or an authorized service center. We recommend you to send your Analyzer for factory calibration every three years.

### 9.2 Storage Instructions

Before first use store your Analyzer in the factory package at environment temperature from 0 to +40 °C and relative humidity up to 80% (at 25 °C).

After you have removed the factory package store the Analyzer at environment temperature from +10 to +35 °C and relative humidity up to 80% (at 25 °C).

Ensure to keep the storage facilities free from dust, fumes of acids and alkalies, aggressive gases, and other chemicals, which can cause corrosion.

## Appendix 1 — Default Settings Table

Default values defined in the process of the initial factory setup.

Parameter Description	Default Setting	Parameter Setting Object
Data Saving Type	State and Calibration	Analyzer
Touchstone Data Format	Real-Imaginary	Analyzer
Allocation of Channels		Analyzer
Active Channel Number	1	Analyzer
Marker Value Identification Capacity (Stimulus)	3 digits	Channel
Marker Value Identification Capacity (Response)	3 digits	Channel
Vertical Divisions	10	Channel
Channel Title Bar	OFF	Channel
Channel Title	Empty	Channel
Traces per Channel	1	Channel
Active Trace Number	1	Channel
Sweep Type	Linear Frequency	Channel
Number of Sweep Points	201	Channel
Stimulus Start Frequency	20 kHz	Channel
Stimulus Stop Frequency		
TR5048	4.8 GHz	Channel
TR7530	3.0 GHz	
Stimulus CW Frequency		
TR5048	2.40001 GHz	Channel
TR7530	1.50001 GHz	
Stimulus Start Power Level	-50 dBm	Channel
Stimulus Stop Power Level	5 dBm	Channel
Stimulus Power Level	-10 dBm	Channel
Stimulus Power Slope	0 dBm	Channel
Stimulus IF Bandwidth	10 kHz	Channel
Sweep Measurement Delay	0 sec.	Channel
Sweep Range Setting	Start / Stop	Channel
Number of Segments	1	Channel
Points per Segment	2	Channel
Segment Start Frequency	20 kHz	Channel



Segment Stop Frequency	20 kHz	Channel
Segment Sweep Power Level	-10 dBm	Channel
Segment Sweep IF Bandwidth	10 kHz	Channel
Segment Sweep Measurement Delay	0 sec.	Channel
Segment Sweep Power Level (Table Display)	OFF	Channel
Segment Sweep IF Bandwidth (Table Display)	OFF	Channel
Segment Sweep Measurement Delay (Table Display)	OFF	Channel
Segment Sweep Range Setting	Start / Stop	Channel
Trigger Mode	Continuous	Channel
Table of Calibration Coefficients	Empty	Analyzer
Error Correction	OFF	Channel
Measurement Parameter	$S_{11}$	Trace
Trace Scale	100 dB	Trace
Reference Level Value	0 dB	Trace
Reference Level Position	5 Div.	Trace
Phase Offset	0°	Trace
Electrical Delay	0 sec.	Trace
Trace Display Format	Logarithmic Magnitude (dB)	Trace
Time Domain Transformation	OFF	Trace
Time Domain Transformation Start	-10 nsec.	Trace
Time Domain Transformation Stop	10 nsec.	Trace
Time Domain Kaiser-Beta	6	Trace
Time Domain Transformation Type	Bandpass	Trace
Number of Markers	0	Trace
Marker Position		
TR5048	2.40001 GHz	Trace
TR7530	1.50001 GHz	